



CVM201 Convection Vacuum Gauge Module *The Super Bee™*



User Manual

InstruTech
1475 S. Fordham St.
Longmont, CO 80503
USA

Phone: +1-303-651-0551
Fax: +1-303-678-1754
E-mail info@instrutechinc.com
www.instrutechinc.com

Important User Information There are operational characteristic differences between solid state equipment and electromechanical equipment. Because of these differences, and because there are a variety of uses for solid state equipment, all persons that apply this equipment must take every precaution and satisfy themselves that the intended application of this equipment is safe and used in an acceptable manner.

In no event will InstruTech be responsible or liable for indirect or consequential damages that result from the use or application of this equipment.

Any examples or diagrams included in this manual are provided solely for illustrative purposes. Because of the many variables and requirements imposed on any particular installation, InstruTech cannot assume responsibility or liability for any actual use based on the examples and diagrams.

No patent liability is assumed by InstruTech with respect to use of information circuits, equipment, or software described in this manual.

Throughout this manual we use notes, notices and apply internationally recognized symbols and safety messages to make you aware of safety considerations.

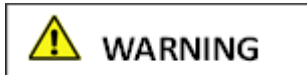

Identifies information about practices or circumstances that can cause electrical or physical hazards which, if precautions are not taken, could result in death or serious injury, property damage, or economic loss.



Identifies information about practices or circumstances that can cause electrical or physical hazards which, if precautions are not taken, could result in minor or moderate injury, property damage, or economic loss.



Identifies information that is critical for successful application and understanding of the product.



Labels may be located on or inside the device to alert people that dangerous voltages may be present.

NOTICE

This User Manual is applicable to the InstruTech® model CVM201 product manufactured with firmware number XXXXX-**68** or XXXXX-**07** (last two digits of **68** or **07**). See Info screen menu described in [section 4.3](#) of this manual to determine the firmware version of your CVM201. For previous versions of CVM201 User Manual manufactured with firmware XXXXX-**67** or XXXXX-**06** or lower (last two digits of **67** or lower and **06** or lower), please go to <http://www.instrutechinc.com/downloads-archived-user-manuals/>.

Copyright © 2012 by InstruTech

All rights reserved. No part of this work may be reproduced or transmitted in any form or by any means, electronic or mechanical, including photocopying and recording, or by any information storage or retrieval system, except as may be expressly permitted in writing by InstruTech.

Printed in the United States of America

Swagelok®, VCO®, VCR® are registered trademarks of Swagelok Co., Solon, OH
Convectron®, Mini-Convectron®, and Granville-Phillips® are registered trademarks of MKS Instruments, Andover, MA
Teflon® is a registered trademark of E. I. du Pont de Nemours and Company, Wilmington, DE
Conflat® is a registered trademark of Varian, Inc. / Agilent Technologies, Lexington, MA

Table of Contents

1	Introduction / General Information	3
1.1	Description	3
1.2	Specifications	3
1.3	Dimensions.....	4
1.4	Part Numbers	4
1.5	Options & Accessories.....	5
2	Important Safety Information.....	6
2.1	Safety Precautions - General.....	6
2.2	Safety Precautions - Service and operation.....	7
2.3	Electrical Conditions.....	7
2.3.1	Proper Equipment Grounding	7
2.3.2	Electrical Interface and Control	7
2.4	Overpressure and use with hazardous gases	8
2.5	Gases other than Nitrogen / air	8
3	Installation	9
3.1	Mechanical Installation.....	9
3.2	Electrical Installation.....	10
3.2.1	Grounding.....	10
3.2.2	Electrical Connections.....	11
4	Setup and Operation.....	12
4.1	Initial Setup	12
4.2	User Interface Basics.....	12
4.3	Programming.....	13
4.4	Return to Factory Default Settings	16
5	Using the gauge with different gases	17

6 Display19

6.1 Display - Torr / mTorr19

6.2 Display - mbar20

7 Analog Output21

7.1 Non-Linear Analog Output - Torr / mTorr22

7.2 Non-Linear Analog Output - mbar24

7.3 Log-Linear Analog Output - Torr25

7.4 Log-Linear Analog Output - mbar27

7.5 Linear Analog Output29

8 RS485 / RS232 serial communications30

8.1 Device Specific Serial Communication Info30

8.2 RS485 / RS232 Command Protocol Summary31

9 Service32

9.1 Calibration32

9.2 Maintenance32

9.3 Troubleshooting32

9.4 Contamination33

9.5 Module and sensor replacement34

10 Factory Service and Support35

11 Warranty35

1 Introduction / General Information

1.1 Description

Thermal conductivity gauges measure pressure indirectly by sensing the loss of heat from a sensor to the surrounding gases. The higher the pressure of the surrounding gas, the more heat is conducted away from the sensor. Pirani thermal conductivity gauges maintain a sensor (usually a wire) at some constant temperature, and measure the current or power required to maintain that temperature. A standard Pirani gauge has a useful measuring range of about 10^{-4} Torr to 10 Torr. By taking advantage of convection currents that are generated above 1 Torr, *convection-enhanced* Pirani gauges increase the measuring range to just above atmosphere.

The InstruTech® CVM201 Super Bee™ module provides the basic signal conditioning required to turn a convection vacuum gauge into a complete measuring instrument. The module provides linear, non-linear or log-linear analog outputs, two setpoint relays and RS232/485 serial communications. In addition, a built-in display provides a convenient user interface for setup and operation of the vacuum gauge.

1.2 Specifications

measurement range	1×10^{-4} to 1,000 Torr / 1.3×10^{-4} to 1,333 mbar / 1.3×10^{-2} Pa to 133 kPa
accuracy - N ₂ (typical)	1×10^{-4} to 1×10^{-3} Torr; 0.1 mTorr resolution 1×10^{-3} to 400 Torr; $\pm 10\%$ of reading 400 to 1,000 Torr; $\pm 2.5\%$ of reading
repeatability - (typical)	$\pm 2\%$ of reading
display	bright OLED, 4 digits, user-selectable Torr, mbar, or Pa, (4 digits from 1100 Torr to 1000 Torr), (3 digits from 999 Torr to 10.0 mTorr), (2 digits from 9.9 mTorr to 1.0 mTorr), (1 digit from 0.9 mTorr to 0.1 mTorr)
materials exposed to gases	gold-plated tungsten, 304 & 316 stainless steel, glass, nickel, Teflon®
internal volume	1.589 in ³ (26 cm ³)
internal surface area	9.25 in ² (59.7 cm ²)
weight	12 oz. (340 g)
housing (electronics)	aluminum extrusion
temperature	operating; 0 to +40 °C storage; -40 to +70 °C
bakeout temperature	150 °C max (gauge only - electronics removed)
humidity	0 to 95% relative humidity, non-condensing
altitude	operating; 8,200 ft. (2,500 m) max storage; 41,000 ft. (12,500 m) max
mounting orientation	horizontal recommended (orientation has no effect on measurements below 1 Torr)
analog outputs	1) log-linear 1 to 8 Vdc, 1 V/decade or non-linear S-curve 0.375 to 5.659 Vdc, and 2) linear 0 to 10 Vdc
serial communications	RS485 / RS232 - ASCII protocol
input power	12 to 28 Vdc, 2 W protected against power reversal and transient over-voltages
setpoint relays	two, single-pole double-throw relays (SPDT), 1 A at 30 Vdc resistive, or ac non-inductive
connectors	9-pin D-sub male and 15-pin high-density D-sub male
CE compliance	EMC Directive 2004/108/EC, EN61326-1, EN55011 Low Voltage Directive 2006/95/EC, EN61010-1
environmental	RoHS compliant

1.3 Dimensions

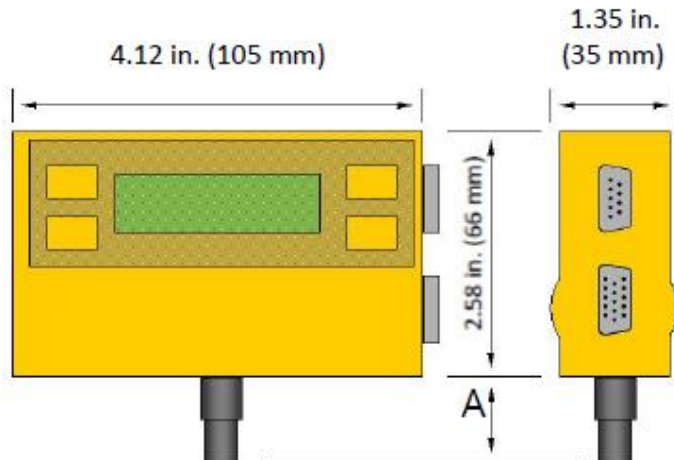

fitting	dimension A
1/8 in. NPT male - 1/2 in. tube	0.86 in. (21.8 mm)
NW16KF	1.16 in. (29.5 mm)
NW25KF	1.16 in. (29.5 mm)
NW40KF	1.16 in. (29.5 mm)
1 1/3 in. Mini-Conflat®	1.34 in. (34.0 mm)
2 3/4 in. Conflat®	1.34 in. (34.0 mm)
1/4 in. Cajon® 4VCR®	1.72 in. (43.7 mm)
1/2 in. Cajon® 8VCR®	1.61 in. (40.9 mm)

1.4 Part Numbers

<i>CVM201 Fittings / Flanges</i>	Part Number
Combination 1/8 in. NPT male - 1/2 in. tube (use 1/8 in. NPT male or 1/2 in. O.D. O-ring compression)	CVM201GAA
NW16KF	CVM201GBA
NW25KF	CVM201GCA
NW40KF	CVM201GDA
1 1/3 in. Mini-CF / NW16CF Mini-Conflat®	CVM201GEA
2 3/4 in. CF / NW35CF Conflat®	CVM201GFA
1/4 in. Cajon® 4VCR® female	CVM201GGA
1/2 in. Cajon® 8VCR® female	CVM201GHA

1.5 Options & Accessories

Optional Wall Mount AC-DC

PS401 Power Supply

Input: 100 - 240 Vac

Output: 24 Vdc @ 750 mA (18 W)

Various AC plugs, 6 ft. cable length



Part Number

with North American AC Plug



PS401-A

with Universal European AC Plug



PS401-EU

with UK AC Plug



PS401-UK

with China AC Plug



PS401-C

with Australian AC Plug



PS401-SP

PS401-UX For Use With User Supplied AC Power Cord



This variation of the PS401 power supply may be used when an AC plug that is not listed above is required. The conventional IEC60320 AC power entry receptacle allows use with any user supplied AC mains power cord set available worldwide.

PS401-UX

Input: 100 - 240 Vac
Output: 24 Vdc @ 2.5 A (60 W)
Cable Length: 6 ft.

2 Important Safety Information

InstruTech has designed and tested this product to provide safe and reliable service, provided it is installed and operated within the *strict safety guidelines provided in this manual*. **Please read and follow all warnings and instructions.**



To avoid serious injury or death, follow the safety information in this document. Failure to comply with these safety procedures could result in serious bodily harm, including death, and or property damage.

Failure to comply with these warnings violates the safety standards of installation and intended use of this instrument. InstruTech disclaims all liability for the customer's failure to comply with these instructions.

Although every attempt has been made to consider most possible installations, InstruTech cannot anticipate every contingency that arises from various installations, operation, or maintenance of the module. If you have any questions about the safe installation and use of this product, please contact InstruTech.

2.1 Safety Precautions - General

The product should never be operated with the enclosure removed.

 **WARNING!** There are no operator serviceable parts or adjustments inside the product enclosure. However, the sensor inside the product enclosure is replaceable. Refer servicing to service trained personnel.

Do not modify this product or substitute any parts without authorization of qualified InstruTech service trained personnel. Return the product to an InstruTech qualified service and repair center to ensure that all safety features are maintained. Do not use this product if unauthorized modifications have been made.

 **WARNING!** Source power must be removed from the product prior to performing any servicing.

After servicing this product, ensure that all safety checks are made by a qualified service person. When replacement parts are required, ensure that the parts are specified by InstruTech. Substitutions of non-qualified parts may result in fire, electric shock or other hazards. Use of unauthorized parts or modifications made to this product will void the warranty.

To reduce the risk of fire or electric shock, do not expose this product to rain or moisture. These products are not waterproof and careful attention must be paid to not spill any type of liquid onto these products. Do not use these products if they have been damaged. Immediately contact InstruTech to arrange return of the product if it is damaged.

Due to the possibility of corrosion when used in certain environmental conditions, it is possible that the product's safety could be compromised over time. It is important that the product be periodically inspected for sound electrical connections and equipment grounding. Do not use if the equipment grounding or electrical insulation has been compromised.

2.2 Safety Precautions - Service and operation

Ensure that the vacuum port on which the CVM201 vacuum gauge is mounted is electrically grounded.

Use an appropriate power source of 12 to 28 Vdc, 2 W.

Turn off power to the unit before attempting to service the module.

Turn off power to the unit if a cable or plug is damaged or the product is not operating normally according to this instruction manual. Contact qualified InstruTech service personnel for any service or troubleshooting condition that may not be covered by this instruction manual.

It is important that the product be periodically inspected for sound electrical connections and equipment grounding. Do not use if the equipment grounding or electrical insulation has been compromised.

Do not use if the unit has been dropped or the enclosure has been damaged. Contact InstruTech for return authorization and instructions for returning the product to InstruTech for evaluation.

2.3 Electrical Conditions

 **WARNING!** When high voltage is present in any vacuum system, a life threatening electrical shock hazard may exist unless all exposed electrical conductors are maintained at earth ground potential. This applies to all products that come in contact with the gas contained in vacuum chambers. An electrical discharge within a gaseous environment may couple dangerous high voltage directly to any ungrounded conductor of electricity. A person could be seriously injured or killed by coming in contact with an exposed, ungrounded electrical conductor at high voltage potential. This condition applies to all products that may come in contact with the gas inside the vacuum chamber (vacuum/pressure containment vessel).

2.3.1 Proper Equipment Grounding

 **WARNING!** Hazardous voltages that could seriously injure or cause death are present in many vacuum processes. Verify that the vacuum port on which the CVM201 vacuum gauge module is mounted is electrically grounded. Consult a qualified Electrician if you are in doubt about your equipment grounding. Proper grounding of your equipment is essential for safety as well as intended operation of the equipment. The CVM201 module vacuum gauge must be connected directly to a good quality earth ground. Use a ground lug on the CVM201 gauge vacuum connection / flange if necessary.

 **WARNING!** In order to protect personnel from electric shock and bodily harm, shield all conductors which are subject to potential high voltage electrical discharges in or around the vacuum system.

2.3.2 Electrical Interface and Control

It is the user's responsibility to ensure that the electrical signals from this product and any connections made to external devices, for example, relays and solenoids, are used in a safe manner. Always double check the system set-up before using any signals to automate your process. Perform a hazardous operation analysis of your

system design and ensure safeguards and personnel safety measures are taken to prevent injury and property damage.

2.4 Overpressure and use with hazardous gases

⚠ WARNING! Install suitable protective devices that will limit the level of pressure inside your vacuum chamber to less than what the vacuum chamber system components are capable of withstanding. InstruTech gauges should not be used at pressures exceeding 1000 Torr absolute pressure.

In cases where an equipment failure could cause a hazardous condition, always implement fail-safe system operation. For example, use a pressure relief device in an automatic backfill operation where a malfunction could result in high internal pressures if the pressure relief device was not installed on the chamber.

The CVM201 vacuum gauge module is not intended for use at pressures above 20 psia (1000 torr); DO NOT exceed 35 psig (< 2 ½ bars) pressure inside the sensor. If your chamber goes to higher pressures, you should install an isolation valve or pressure relief device to protect the gauge tube from overpressure conditions. With some fittings, actual safe overpressure conditions may be lower; for example, a quick-connect, O-ring compression fitting may forcibly release the gauge tube from the vacuum chamber fitting with only a few psi over local uncorrected barometric (atmospheric) pressure.

⚠ CAUTION! If the internal pressure of a vacuum gauge device is allowed to increase above local uncorrected barometric pressure (atmospheric pressure side), vacuum fittings may release and possible overpressure conditions may cause leaks that would allow the gas inside the gauge tube to release into the atmosphere of the surrounding environment. Toxic, pyrophoric and flammable gases are examples of hazardous gases that if allowed to leak out of the vacuum/pressure containment vessel into the atmospheric environment, could cause bodily injury and possible damage to equipment. Never expose the gauge tube internal volume to pressure above local atmospheric pressure when using hazardous gases.

2.5 Gases other than Nitrogen / air

⚠ WARNING! Do not attempt to use with gases other than nitrogen (N₂) or air without referring to correction factor data tables.

InstruTech gauges and modules are calibrated for direct readout of nitrogen or air. Do not attempt to use with other gases such as argon (Ar) or carbon dioxide (CO₂) unless accurate conversion data for N₂ to other gas is properly used. Refer to sections titled [“Using the gauge with different gases”](#), [“Display”](#) and [“Analog Output”](#) for a more complete discussion.

⚠ WARNING! Do not use this device in an explosive atmosphere or in the presence of flammable gases, vapors or fumes. Do not use this device to measure the pressure of explosive or combustible gases or gas mixtures. The sensor wire in the gauge normally operates at 125 °C, but if malfunction should occur, the wire temperature could exceed the ignition temperature of certain combustible gases and gas mixture. This could cause an explosion which could result in serious injury or death.

3 Installation

3.1 Mechanical Installation

Mount the CVM201 as close as possible to the pressure you want to measure. Long or restricted, small diameter tubing will create a pressure difference between your process chamber and the gauge. This may cause a delay in response to pressure changes.

Mounting the CVM201 too close to a gas source inlet may also cause measurement and control instability. Do not mount the CVM201 near a source of heating or cooling, such as heaters or air conditioning vents.

Mount the CVM201 with its main (long) axis horizontal (see diagram below). Pressure reading errors may occur above 1 Torr if the unit is not mounted horizontally. Below 1 Torr, mounting position has little to no effect.

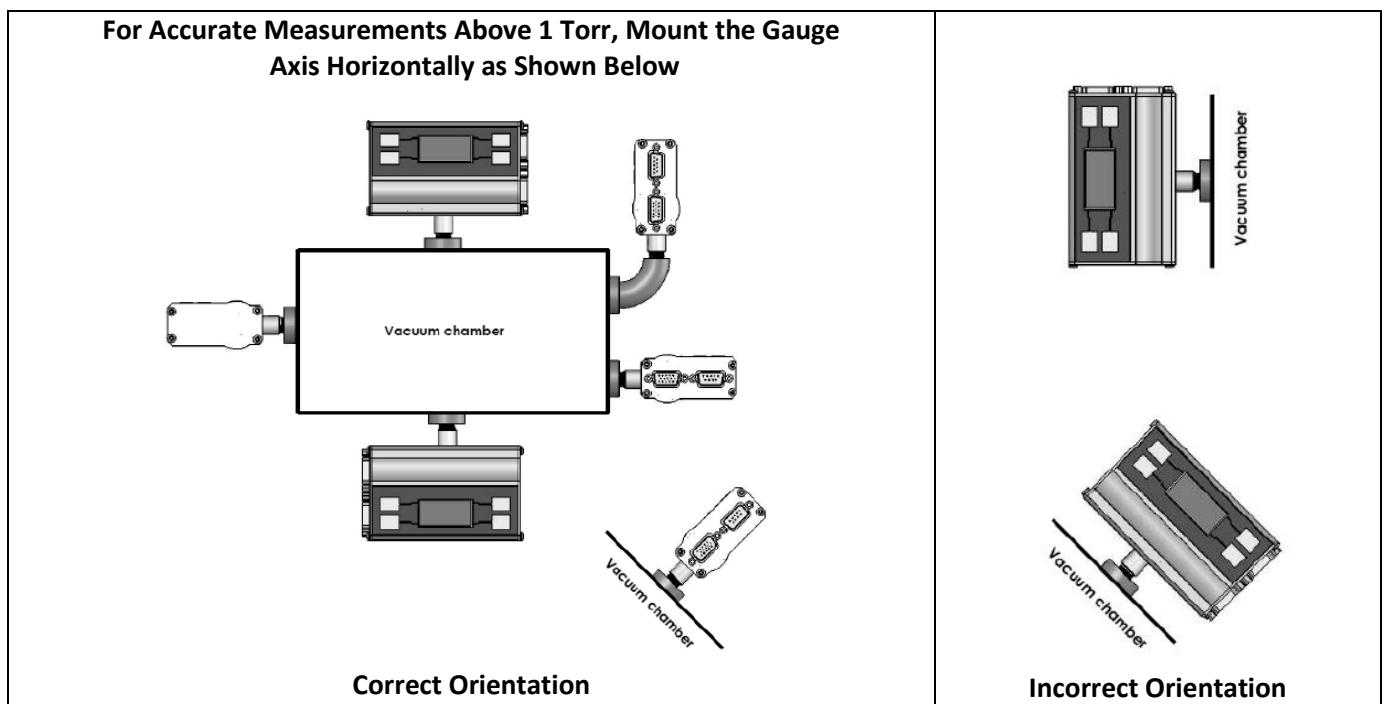

Mount the CVM201 with port down, if possible, to help minimize the effect of any particles or condensation from collecting in the gauge.

Do not mount the CVM201 where it will be subjected to excessive vibration. Vibrations may cause unstable readings, measurement errors and possible mechanical stress to components in the CVM201.

Flanges/ Fittings - follow the manufacturer's recommendations and note the following:

- NPT fittings: When connecting the device using a NPT fitting, apply a thread sealant or wrap the threaded portion of the tubing with one-and-a-half to two wraps of pipe thread seal tape such as PTFE (Teflon®) tape and hand tighten the gauge into the gauge port. Do not use a wrench or other tool which may damage the gauge.

3.2 Electrical Installation

3.2.1 Grounding

⚠ Be sure the vacuum gauge and the rest of your vacuum system are properly grounded for safety as well as intended operation of the equipment. When using KF flanges, metal clamps must be used to ensure proper grounding. Be aware that some vacuum fittings such as NPT connections installed using Teflon tape may not allow for metal-to-metal contact between the vacuum gauge and the vacuum chamber. If such is the case, use a 12 gauge or larger copper wire to connect the vacuum gauge to a ground lug on your vacuum chamber as shown below.

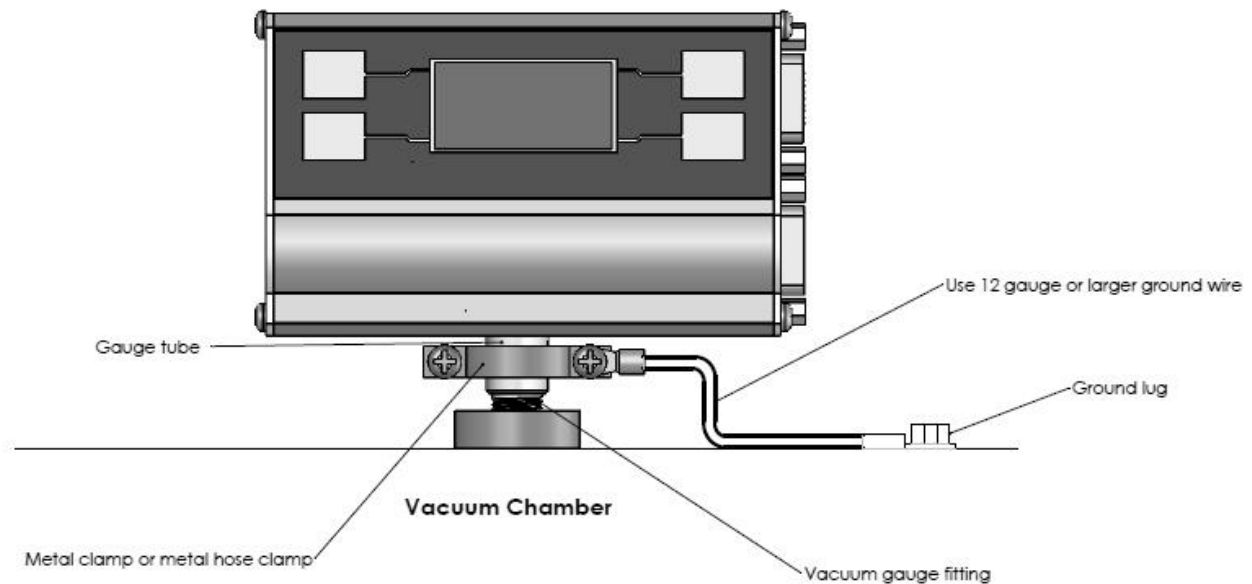

3.2.2 Electrical Connections

A good recommended practice is to remove power from any cable prior to connecting or disconnecting it. Do not connect power to both the 9-pin and 15-pin D-Sub Connectors. Apply power only to one or the other. The InstruTech CVM201 will directly replace Granville-Phillips® Mini-Convectron® modules that have a 9-pin D-sub connector (DE-9P) or 15-pin D-sub connector (DE-15P), and you can use your existing cables and electronics. For new installations, fabricate a cable to connect to the signals/functions you want to use. When using RS232 or RS485 serial communications, you must fabricate your own cable according to the 15-pin D-Sub pinout shown below. A standard off-the-shelf serial communications cable will not work. All signals and pin assignments are described below:

9-pin D-sub Connector pinout

PIN NUMBER	PIN DESCRIPTION
1	Relay 1 Normally Open
2	Relay 1 Normally Closed
3	Power Input (12-28 Vdc)
4	Power Ground
5	Analog Output 1 (Log-Linear 1-8V, or Non-linear Granville-Phillips® Mini-Convectron® compatible)
6	Relay 1 Common
7	Relay Disable (Disables both Relays when connected to pin 4 - Ground)
8	Analog Ground
9	Analog Output 2 (Programmable Linear 0-10 V)

15-pin D-sub Connector pinout

PIN NUMBER	PIN DESCRIPTION
1	RS485 DATA B (+) Input/output
2	RS485 DATA A (-) Input/output
3	Power Input (12-28 Vdc)
4	Power Ground (Also when using serial communications, this pin is typically connected to pin # 5 of your PC RS232 serial port 9-pin D-sub connector, or ground pin of your RS485 converter)
5	Analog Output 1 (Log-Linear 1-8 V, or Non-linear Granville-Phillips® Mini-Convectron® compatible)
6	Analog Ground
7	RS232 TX (This pin is typically connected to pin # 2 of your PC serial port 9-pin D-sub connector)
8	RS232 RX (This pin is typically connected to pin # 3 of your PC serial port 9-pin D-sub connector)
9	Relay Disable (Disables both Relays when connected to pin 4 - Ground)
10	Relay 1 Normally Open
11	Relay 2 Normally Open
12	Relay 2 Common
13	Relay 2 Normally Closed
14	Relay 1 Normally Closed
15	Relay 1 Common

4 Setup and Operation

4.1 Initial Setup

Two of the most important steps for the initial setup of the gauge are to set zero (*SET VAC*) and set atmosphere (*SET ATM*) as described in the *Programming* [section 4.3](#) below. This will ensure proper operation of the gauge and accurate pressure measurements. The gauge is calibrated at the factory using nitrogen. Furthermore, the gauge is also installed in a certain orientation when calibrated at the factory. Without setting zero and atmosphere after the gauge is installed in your system, the gauge may not display the expected and correct pressures. This could be caused by the fact that you may be using a different gas than Nitrogen such as air to setup and calibrate the gauge (most commonly the case) and the gauge orientation is different than the orientation used at the factory. As such, it is very important to perform your own initial setup and calibration by setting zero and atmosphere with the gauge installed in your actual system. Please note the following:

Setting zero (*SET VAC*): Setting zero optimizes performance of the gauge when operating at a low pressure range of 1.00×10^{-4} Torr to 1.00×10^{-3} Torr. If your minimum operating pressure is higher than 1.00×10^{-3} Torr, it is not normally necessary to set zero and thus setting atmosphere should be adequate. If you are able to evacuate your system to below 1.00×10^{-4} Torr, it is always a good practice to check and set zero if necessary. See “*SET VAC*” in [section 4.3](#)

Setting Atmosphere (*SET ATM*): Setting atmosphere is the most important step for a newly installed gauge. If you prefer to use air to set atmosphere, vent your vacuum system chamber to expose the gauge to the local atmospheric pressure (air) and set atmosphere to match your known local uncorrected barometric pressure (air). This is the reading of ambient air pressure you will expect if you were to vent and open your vacuum chamber to the atmosphere surrounding the outside of your chamber. At sea level, this pressure is usually near 760 Torr. At elevations above sea level, the pressure decreases. Check your local aviation authority or airport web sites or your current local weather conditions online to help find your local uncorrected barometric pressure if you do not have this information. See “*SET ATM*” in [section 4.3](#)

Note - Setting zero and atmosphere is normally required only once during the initial setup and maybe checked by the user periodically. After power has been applied to the gauge during the initial setup, allow five minutes for the gauge to stabilize (warm-up) before setting zero and atmosphere.

4.2 User Interface Basics

The user interface is designed for easy operation and a natural progression of setup parameters. This section gives a brief explanation of operation for added clarity.

There are four soft-keys located on the front panel, two on each side of the display. These keys are used to select and program the various functions available. During programming of the CVM201, the display will identify what function each key represents. To begin programming, press any one of the four keys. The display will indicate a choice of functions. Press the key indicated by the function on the display to continue with the programming of the parameter desired. After setting the various parameters, press the SAVE key to save the new setting and return to the main screen. To continue setting additional parameters, scroll forward with the MORE key until you reach the desired parameter.



Programming soft-keys

4.3 Programming

SET VAC

NOTICE

When operating in units of either mbar or pascals (Pa), you must perform SET ATM before setting the vacuum reading (SET VAC). See SET ATM below. Failure to do so will result in improper operation of the gauge. If you change units of measure or reset to factory defaults, then this same procedure must be followed again if the units of measure are being set to either mbar or Pa.

1. To properly set the vacuum reading (“zero” point), with the CVM201 installed on your vacuum system, the gauge should be evacuated to a pressure below 1.00×10^{-4} Torr.
2. Go to the **SET VAC** screen. When the vacuum system pressure is below 1.00×10^{-4} Torr, press the **PRESS TO SET VAC** key. The zero point (displayed pressure reading with gauge exposed to vacuum) is now set.

UNITS [Factory default = TORR]

This should be the first parameter that is set. This will be the units-of-measure (TORR, mBAR, PASCAL) that are used for all other settings. If your CVM201 has been previously configured and relay setpoints and linear analog output pressure settings have been programmed, changing units-of-measure will return the relays setpoints and the linear analog output pressure settings to factory default setting values in TORR. In this case, you must reprogram the relay setpoints and linear analog output pressure settings in the newly programmed units-of-measure.

SET ATM

1. To set the atmospheric pressure reading (also known as the “span” adjustment), flow nitrogen gas or air into your closed vacuum chamber to allow the pressure to rise to a known value above 400 Torr. Alternatively, if your local uncorrected barometric pressure (air) is known, simply vent your vacuum system chamber to expose the gauge to the local atmospheric pressure.
2. Go to the **SET ATM** screen. When the desired pressure is stable, adjust the displayed pressure reading on the CVM201 to the known value using the **INCR** (increase) or **DECR** (decrease) keys. Press the **SAVE** key to save the new atmospheric (span) pressure value. For example, if your known local uncorrected barometric pressure is 760 Torr, enter 760 in the SET ATM screen. The main pressure measurement screen will now display 760 Torr while the gauge is at atmosphere.

It is good practice to perform the sequence of checking and adjusting span (ATM) then zero (VAC) and then, finally re-checking the span setting to ensure that the circuitry is properly balanced for use in measuring pressure throughout the intended measurement range.

SP1 ON and SP2 ON [Factory default = 100 mTORR]

These setpoints correspond to the pressures at which the relays will turn on (energize). The relays will turn on when the pressure is below the programmed pressure value. If you are unable to increase the values of SP1 ON or SP2 ON, you must first go to SP1 OFF or SP2 OFF and increase those values to a number higher than the values of SP1 ON or SP2 ON you are trying to set.

SP1 OFF and SP2 OFF [Factory default = 200 mTORR]

These setpoints correspond to the pressures at which the relays will turn off (de-energize). The relays will turn off when the pressure is above the programmed pressure value. If you are unable to decrease the values of SP1 OFF or SP2 OFF, you must first go to SP1 ON or SP2 ON and decrease those values to a number lower than the values of SP1 OFF or SP2 OFF you are trying to set.

RS485 ADDR [Factory default = 1]

This is the lower nibble of the one byte RS485 device address. Assuming the address offset (RS485 OFFSET) is equal to 0, setting the ADDR to a 5 will make the address be 0x05 in hexadecimal. A 15 will set the ADDR to 0x0F in hexadecimal. Note that the address (ADDR) must be used even when sending RS232 commands

RS485 OFFSET [Factory default = 0]

This is the upper nibble of the one byte RS485 address. Assuming the address (ADDR) is 0, setting the address offset (RS485 OFFSET) to a 5 will make the address be 0x50 hexadecimal. Setting the address offset to 15 will make the device address be 0xF0 hexadecimal.

BINARY ADDRESS			
ADDRESS DECIMAL	ONE BYTE (BINARY)		ADDRESS HEXADECIMAL
	ADDR OFFSET ┌Upper nibble┐	ADDR ┌Lower nibble┐	
1	0 0 0 0	0 0 0 1	01
5	0 0 0 0	0 1 0 1	05
15	0 0 0 0	1 1 1 1	0F
16	0 0 0 1	0 0 0 0	F0

BAUD [Factory default = 19,200]

This sets the baud rate for the RS485 and the RS232 serial communications. The baud rate can be set to various values through the serial interface or via the front panel soft-keys. The parity can only be changed through the serial interface command set. When this occurs, the current setting will be shown in the list of choices and can be re-selected if changed.

SET LINEAR [Factory default = 0.01 VOLTS to 10 VOLTS corresponding to 1 mTORR to 1 TORR]

This will take the user to four different screens to setup the linear analog output ([See Analog Output section](#)).

- a) Set the minimum pressure
- b) Set the minimum voltage corresponding to the minimum pressure
- c) Set the maximum pressure
- d) Set the maximum voltage corresponding to the maximum pressure

Note - The *LINEAR* analog output provides a linear 0-10 Vdc output signal. The linear output voltage can be any value between 10 mV and 10 V corresponding to displayed pressure between 1 mTorr and 1000 Torr. However, the useful range of the linear analog output is three decades. If your application requires the analog output to cover a pressure range exceeding three decades then consider using the non-linear or the log-linear analog output. See ANALOG TYPE menu below to select log-linear or non-linear analog output.

INFO

This screen shows the unit software version.

ANALOG TYPE [Factory default = NONLIN]

Select “NONLIN” for non-linear (S-Curve) or “LOG” for log-linear analog output ([See Analog Output section](#)).

AOUT CAL [Factory default = Factory Set]

This has been pre-set in the factory and is used to optimize the analog output calibration. It is recommended that the user not make this adjustment unless the displayed pressure on the CVM201 and the resulting pressure calculation from the analog output do not match closely. To perform this adjustment, connect the CVM201 analog output to a high resolution voltmeter, your system, PLC, etc. While in the *AOUT CAL* screen and with the gauge exposed to atmosphere, use the INC or DECR soft-keys to adjust the analog output to match the corresponding pressure displayed on the screen. Example: The CVM201 ANALOG TYPE menu above is set to LOG. In the *AOUT CAL* screen, the atmospheric pressure is displayed at 760 Torr. Based on the equation and table given in [section 7.3](#) the expected analog output at 760 Torr is 7.881 V. Use the INC or DECR soft-keys in the *AOUT CAL* screen to set the analog output to 7.881 V as recorded by your voltmeter, PLC, etc. Alternatively, if the analog output is used to display the pressure in your PLC or system display console, adjust the *AOUT CAL* while the gauge is exposed to atmosphere so that the atmospheric pressure displayed by your PLC matches the atmospheric pressure displayed by the CVM201. The *AOUT CAL* can be performed at any pressure between 400 Torr to 999 Torr (atmosphere recommended).

SCREEN SAVER [Factory default = ON]

The CVM201 uses an OLED type display which over an extended period of time can start to show divergence between pixels that are on at all times versus pixels that are not. This could result in pixels exhibiting a burned-in effect. To minimize the burned-in effect, a screen saver function can be activated by programming the *SCREEN SAVER* menu selection to ON. With the screen saver function turned on, the display appearance changes every 12 hours. The display will appear in the normal mode with a dark background color for the first 12 hours and will then switch to a back-lit background color for the next 12 hours. If you like to have the 12 hour period for the normal display mode to start at a specific time of the day, simply access the *SCREEN SAVER* menu and change setting to OFF and then ON again. This initiates the screen saver function immediately.

Note - To increase longevity of the OLED display, InstruTech recommends that the screen saver function remains ON as shipped from the factory.

AOUT OFFSET

It is recommended that the user not make this adjustment unless it is critical for your application that when the display of CVM201 reads zero (0.00 mTorr), your data acquisition system (using the analog output from the CVM201) also registers a pressure reading of exactly zero. Please note that adjusting the *AOUT OFFSET* will affect the analog output calibration at atmosphere (see *AOUT CAL* menu above). As such, avoid changing the *AOUT OFFSET* unless it is critical for display and analog output to exactly match when the displayed pressure is zero.

To perform this adjustment, pump your system down to below 0.1 mTorr and SET VAC (zero) so that the CVM201 displayed pressure shows 0.0 mTorr. Connect the CVM201 analog output to a high resolution voltmeter, your system, PLC, etc. While in the *AOUT OFFSET* screen, use the INC or DECR soft-keys to adjust the analog output to match the corresponding zero pressure displayed on the screen.

Example 1: The CVM201 ANALOG TYPE menu above is set to LOG. In the *AOUT OFFSET* screen, the pressure is displayed at 0.00 mTorr. The expected analog output at 0.00 mTorr is 0.954 V. Use the INC or DECR soft-keys in

the AOUT CAL screen to set the analog output to 0.954 V as recorded by your voltmeter, PLC, etc. Alternatively, if the analog output is used to display the pressure in your PLC or system display console, adjust the *AOUT OFFSET* so that your PLC also reads 0.0 mTorr.

Example 2: The CVM201 ANALOG TYPE menu above is set to NONLIN (Non-Linear). In the *AOUT OFFSET* screen, the pressure is displayed at 0.00 mTorr. Based on the equation and table given in [section 7.1](#) the expected analog output at 0.00 mTorr is 0.375 V. Use the INC or DECR soft-keys in the AOUT CAL screen to set the analog output to 0.375 V as recorded by your voltmeter, PLC, etc. Alternatively, if the analog output is used to display the pressure in your PLC or system display console, adjust the *AOUT OFFSET* so that your PLC also reads 0.0 mTorr.

4.4 Return to Factory Default Settings

You can reset all values to the original factory default settings by simultaneously pressing the upper left and upper right soft-keys. The user will then be prompted “Set Factory Defaults?” Choose Yes or No.

If you reset all values to original factory default settings, you would need to repeat the initial setup procedure as described in [section 4.1](#) and reprogram other parameters as required.

5 Using the gauge with different gases

A thermal conductivity gauge senses heat loss which depends on the thermal conductivity of the gas surrounding the sensor. Since different gases, and mixtures, have different thermal conductivities, the indicated pressure readings and outputs will also be different. InstruTech convection gauges (and most other thermal conductivity gauges) are calibrated using nitrogen (N₂). When a gas other than N₂ / air is used, correction must be made for the difference in thermal conductivity between nitrogen (N₂) and the gas in use. The charts and tables on the following pages indicate how different gases affect the display and output from an InstruTech convection gauge.

 **WARNING!** Using a thermal conductivity gauge with gases other than that for which it is calibrated could result in death or serious injury. Be sure to use gas correction data in this manual when measuring pressures of gases other than N₂ / air.

For N₂ the calibration shows excellent agreement between indicated and true pressure throughout the range from 10⁻⁴ to 1000 Torr. At pressures below 1 Torr, the calibration curves for the different gases are similar. The difference in readings at these low pressures is a constant, a function of the difference between thermal conductivities of the gases.

At pressures above 1 Torr, indicated pressure readings may diverge significantly. At these higher pressures convection currents in the gauge become the predominant cause of heat loss from the sensor and calibration depends on gauge tube geometry and mounting position as well as gas properties.

Generally, air and N₂ are considered the same with respect to thermal conductivity, but even N₂ and air will exhibit slight differences in readings at higher pressures. For example, when venting a system to atmosphere using N₂, you may see readings change by 30 to 40 Torr after the chamber is opened and air gradually displaces the N₂ in the gauge. For most other gases the effect is much more significant and may result in a hazardous condition as described below.

Other considerations when using gases other than N₂ / air

Flammable or explosive gases

 **WARNING!** InstruTech convection gauges are neither intrinsically safe nor explosion proof and are not intended for use in the presence of flammable or explosive gases or vapors.

Under normal conditions the voltages and currents in InstruTech convection gauges are too low to cause ignition of flammable gases. However, under certain failure conditions, sufficient energy could be generated to cause flammable vapors or gases to ignite or explode. Thermal conductivity gauges like the InstruTech convection gauges are not recommended for use with flammable or explosive gases.

Moisture / water vapor

In some processes (lyophilization, for example) the gas composition may not change significantly, except for moisture content. Water vapor can significantly change the response of a thermal gauge and correction should be made, as you would for any other gas.

Other contaminants

If your gases condense, coat, or corrode the sensor, the gauge calibration and response to different gases will change. Generally, if the gauge can be "calibrated" ("zero" and "span" settings), these changes are small enough to be ignored. If you can't set zero and span, the gauge should be replaced or return to factory for evaluation and possible cleaning.

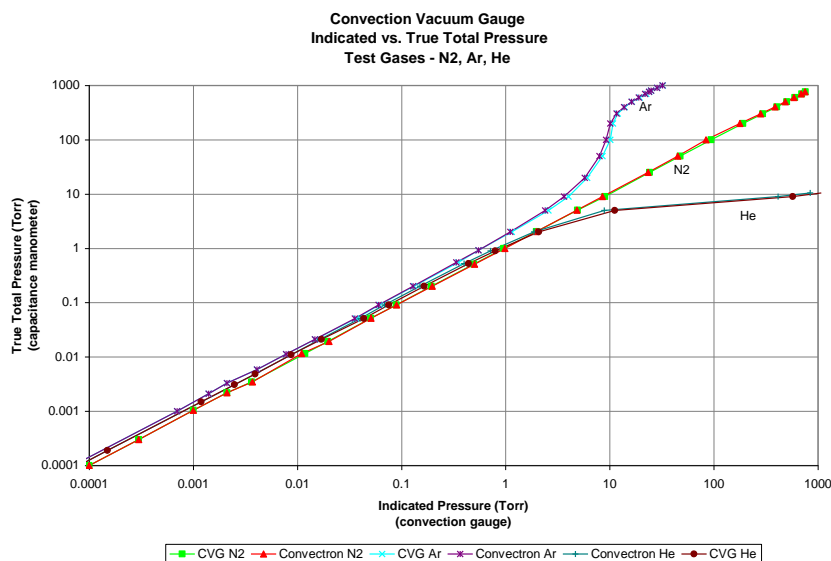

Gas Correction Chart

The Y-axis of the above chart is actual pressure as measured by a capacitance manometer, a diaphragm gauge that measures true total pressure independent of gas composition. The X-axis is the pressure reading indicated by the convection gauge under test. This chart shows readings for an InstruTech convection gauge (CVG) and Granville-Phillips® Convectron® gauge to illustrate that the difference in the response for both of these types of gauges is virtually indistinguishable.

CAUTION! Do not assume this data applies to other convection gauges which may or may not be the same. Refer to the table in [section 6.1](#) and note the following examples:

Example A: If the gas is nitrogen (N₂), when the true total pressure is 500 Torr, the gauge will read 500 Torr.

Example B: If the gas is argon (Ar), when the true pressure is 100 Torr, the gauge will read about 9 Torr.

If you are backfilling your vacuum system with Ar, when your system reaches a pressure of 760 Torr true pressure your gauge will be reading about 23 Torr. Continuing to backfill your system, attempting to increase the reading up to 760 Torr, you will over pressurize your chamber which may present a hazard.

Example C: If the gas is helium (He), the gauge will over pressure (OP) when pressure reaches about 10 Torr true pressure and opening the chamber to atmosphere prematurely may present other hazards for both people and product.

CAUTION! What these examples illustrate is that using gases other than nitrogen (N₂) without using accurate gas conversion data and other proper precautions could result in injury to personnel and/or damage to equipment.

Suggested precautions when using gases other than nitrogen (N₂):

Install a pressure relief valve or burst disk on your chamber, to protect it from overpressure. Post a warning label on your gauge readout that states "Do Not Exceed ____ Torr Indicated Pressure" (fill in the blank for maximum indicated pressure for the gas you use) so that an operator using the gauge will not exceed a safe pressure.

6 Display

6.1 Display - Torr / mTorr

The table below shows the displayed readings at various pressures for selected gases when engineering units selected is in Torr/mTorr.

Displayed Pressure Readings vs. True Pressure for selected gases

Pressures shown in bold italic font in the shaded areas are in mTorr.

Pressures shown in normal font and in non-shaded areas are in Torr.

True Total Pressure	N ₂	Ar	He	O ₂	CO ₂	Kr	Freon12	Freon22	D ₂	Ne	CH ₄
0 mTorr	0.0	0.0	0.0	0.0	0.0	0.0	0.0	0.0	0.0	0.0	0.0
0.1 mTorr	0.1	0.1	0.1	0.1	0.1	0.1	0.1	0.1	0.1	0.1	0.1
0.2 mTorr	0.2	0.2	0.2	0.2	0.2	0.2	0.2	0.2	0.2	0.2	0.2
0.5 mTorr	0.5	0.5	0.5	0.5	0.5	0.3	0.5	0.5	0.5	0.5	0.5
1 mTorr	1.0	0.7	0.8	1.0	1.1	0.4	1.5	1.5	1.3	0.7	1.7
2 mTorr	2.0	1.4	1.6	2.0	2.3	1.0	3.1	3.1	2.4	1.5	3.3
5 mTorr	5.0	3.3	4.0	5.0	4.4	2.3	7.6	7.0	6.0	3.5	7.7
10 mTorr	10.0	6.6	8.1	9.7	11.0	4.8	14.7	13.5	12.1	7.1	15.3
20 mTorr	20.0	13.1	16.1	19.8	22.2	9.5	29.9	27.2	24.3	14.1	30.4
50 mTorr	50.0	32.4	40.5	49.2	54.9	23.5	72.5	69.0	60.0	34.8	77.2
100 mTorr	100	64.3	82.0	97.2	107	46.8	143	136	121	70.0	159
200 mTorr	200	126	165	194	210	91.1	275	262	250	141	315
500 mTorr	500	312	435	486	489	217	611	594	687	359	781
1 Torr	1.00	600	940	970	950	400	1.05	1.04	1.55	745	1.60
2 Torr	2.00	1.14	2.22	1.94	1.71	700	1.62	1.66	4.13	1.59	3.33
5 Torr	5.00	2.45	13.5	4.98	3.34	1.28	2.45	2.62	246	5.24	7.53
10 Torr	10.0	4.00	OP	10.3	4.97	1.78	2.96	3.39	OP	21.5	27.9
20 Torr	20.0	5.80	OP	22.3	6.59	2.29	3.32	3.72	OP	584	355
50 Torr	50.0	7.85	OP	77.6	8.22	2.57	3.79	4.14	OP	OP	842
100 Torr	100	8.83	OP	209	9.25	2.74	4.68	4.91	OP	OP	OP
200 Torr	200	9.79	OP	295	12.3	3.32	5.99	6.42	OP	OP	OP
300 Torr	300	11.3	OP	380	16.9	3.59	6.89	7.52	OP	OP	OP
400 Torr	400	13.5	OP	485	22.4	3.94	7.63	8.42	OP	OP	OP
500 Torr	500	16.1	OP	604	28.7	4.21	8.28	9.21	OP	OP	OP
600 Torr	600	18.8	OP	730	36.4	4.44	8.86	9.95	OP	OP	OP
700 Torr	700	21.8	OP	859	46.1	4.65	9.42	10.7	OP	OP	OP
760 Torr	760	23.7	OP	941	53.9	4.75	9.76	11.1	OP	OP	OP
800 Torr	800	25.1	OP	997	59.4	4.84	9.95	11.4	OP	OP	OP
900 Torr	900	28.5	OP	OP	79.5	4.99	10.5	12.0	OP	OP	OP
1000 Torr	1000	32.5	OP	OP	111	5.08	11.1	12.7	OP	OP	OP

Notes:

- 1) OP = overpressure indication: display will read over pressure
- 2) Display auto-ranges between Torr and mTorr at 1 Torr

Examples:

- 1) Gas used is nitrogen (N₂). Display shows pressure measurement of 10 Torr. True pressure of nitrogen is 10 Torr.
- 2) Gas used is argon (Ar). Display shows pressure measurement of 600 mTorr. True pressure of argon is 1 Torr.
- 3) Gas used is oxygen (O₂). Display shows pressure measurement of 486 mTorr. True pressure of oxygen is 500 mTorr.

6.2 Display - mbar

The table below shows the displayed readings at various pressures for selected gases when engineering units selected is in mbar.

Displayed Pressure Readings vs. True Pressure for selected gases - Engineering units in mbar

True Pressure	N ₂	Ar	He	O ₂	CO ₂	KR	Freon12	Freon22	D ₂	Ne	CH ₄
0 mbar	0.0	0.0	0.0	0.0	0.0	0.0	0.0	0.0	0.0	0.0	0.0
.0001 mbar	.0001	.0001	.0001	.0001	.0001	.0001	.0001	.0001	.0001	.0001	.0001
.0003 mbar	.0003	.0003	.0003	.0003	.0003	.0003	.0003	.0003	.0003	.0003	.0003
.0006 mbar	.0006	.0006	.0006	.0006	.0006	.0004	.0006	.0006	.0006	.0006	.0006
.0013 mbar	.0013	.0009	.0011	.0013	.0015	.0005	.0020	.0020	.0017	.0009	.0023
.0027 mbar	.0027	.0019	.0021	.0027	.0031	.0013	.0041	.0041	.0032	.0020	.0044
.0067 mbar	.0067	.0044	.0053	.0067	.0059	.0031	.0101	.0093	.0080	.0047	.0102
.0133 mbar	.0133	.0088	.0107	.0129	.0146	.0064	.0195	.0179	.0161	.0095	.0203
.0260 mbar	.0260	.0174	.0214	.0263	.0295	.0126	.0398	.0362	.0323	.0187	.0405
.0666 mbar	.0666	.0431	.0539	.0655	.0731	.0313	.0966	.0919	.0799	.0463	0.100
0.130 mbar	0.130	.0857	0.110	0.120	0.140	.0623	0.190	0.180	0.160	0.100	0.210
0.260 mbar	0.260	0.160	0.210	0.250	0.270	0.120	0.360	0.340	0.330	0.180	0.410
0.666 mbar	0.666	0.410	0.570	0.640	0.650	0.280	0.810	0.790	0.91	0.470	1.04
1.33 mbar	1.33	0.790	1.25	1.29	1.26	0.530	1.39	1.38	2.06	0.990	2.13
2.66 mbar	2.66	1.51	2.95	2.58	2.27	0.930	2.15	2.21	5.50	2.11	4.43
6.66 mbar	6.66	3.26	17.9	6.63	4.45	1.70	3.26	3.49	327	6.98	10.0
13.3 mbar	13.3	5.33	OP	13.7	6.62	2.37	3.94	4.51	OP	28.6	37.1
26.6 mbar	26.6	7.73	OP	29.7	8.78	3.05	4.42	4.95	OP	778	473
66.6 mbar	66.6	10.4	OP	103	10.9	3.42	5.05	5.51	OP	OP	1012
133 mbar	133	11.7	OP	278	12.3	3.65	6.23	6.54	OP	OP	OP
266 mbar	266	13.0	OP	393	16.3	4.42	7.98	8.55	OP	OP	OP
400 mbar	400	15.0	OP	506	22.5	4.78	9.18	10.0	OP	OP	OP
533 mbar	533	17.9	OP	646	29.8	5.25	10.1	11.2	OP	OP	OP
666 mbar	666	21.4	OP	805	38.2	5.61	11.0	12.2	OP	OP	OP
800 mbar	800	25.0	OP	973	48.5	5.91	11.8	13.2	OP	OP	OP
933 mbar	933	29.0	OP	1140	61.4	6.19	12.5	14.2	OP	OP	OP
1011 mbar	1011	31.5	OP	1250	71.8	6.33	13.0	14.7	OP	OP	OP
1060 mbar	1060	33.4	OP	1320	79.1	6.45	13.2	15.1	OP	OP	OP
1190 mbar	1019	37.9	OP	OP	105	6.65	13.9	16.0	OP	OP	OP
1330 mbar	1330	43.3	OP	OP	147	6.77	14.7	16.9	OP	OP	OP

Values listed under each gas type are in mbar.

Notes:

- 1) OP = Overpressure indication; display will read "overpressure".

Examples:

- 1) Gas used is nitrogen. Display shows pressure measurement of 13.3 mbar. True pressure of nitrogen is 13.3 mbar.
- 2) Gas used is argon. Display shows pressure measurement of 11.7 mbar. True pressure of argon is 133 mbar.
- 3) Gas used is CO₂. Display shows pressure measurement of .0731 mbar. True pressure of CO₂ is .0666 mbar.

7 Analog Output

The CVM201 provides either a non-linear or a log-linear analog output. Additionally it can provide a linear 0-10 Vdc analog output.

Non-Linear Output

The first Convectron® gauge controllers produced a non-linear output signal of 0.375 to 5.659 Vdc for 0 to 1000 Torr of N₂, roughly in the shape of an "S" curve, as shown at right. Granville-Phillips® adopted the same output curve for most of their Mini-Convectron® modules and controllers with non-linear output (although in recent years, some Granville-Phillips® controllers may output variations of the original S-curve).

The non-linear output from InstruTech convection gauges, modules and controllers duplicates the original S-curve of 0.375 to 5.659 Vdc for 0 to 1000 Torr.

The tables shown in [section 7.1](#) and [7.2](#) contain the lookup data for converting the *non-linear* output voltage into pressure values for nitrogen and various other gases.

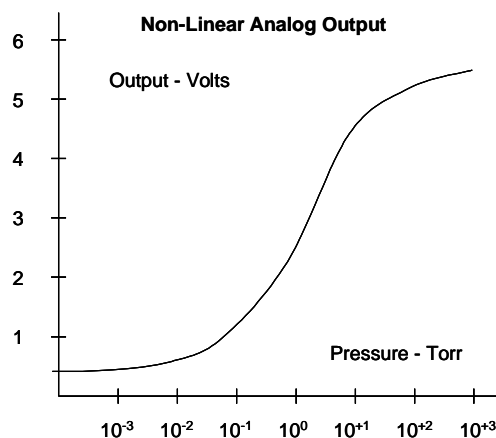

Log-Linear Output

Many InstruTech modules and controllers also provide a log-linear output signal, as an alternative to the non-linear signal described above. This output, shown at right, is a 1 Volt per decade signal that may be easier to use for data logging or control.

The table shown in [section 7.3](#) and [7.4](#) contain the lookup data and provides the formulas for converting the *log-linear* output voltage into pressure values for nitrogen and various other gases.

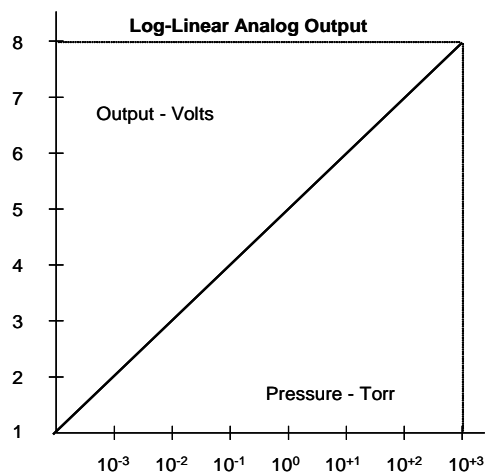

Linear 0-10 Vdc Analog Output

The CVM201 also provides a linear 0-10 Vdc analog output. The linear output voltage can be any value between 10 mV and 10 V corresponding to displayed pressure between 1 mTorr and 1000 Torr. However, the useful range of the linear analog output is three decades. For example if the minimum pressure selected is 1 mTorr (1.00×10^{-3} Torr) with a corresponding minimum voltage output of 0.01 volts, then maximum pressure selected to correspond to a maximum voltage output of 10 volts should not exceed 1.0 Torr. If your application requires the analog output to cover a pressure range exceeding three decades then consider using the non-linear or the log-linear analog output. An analog output of less than 0.01 volts to near 0 volt indicates a damaged or faulty sensor.

7.1 Non-Linear Analog Output - Torr / mTorr

You may calculate the N₂/air pressure represented by the **0.375 to 5.659 V** non-linear analog output voltage for the “S-curve” using a multi-segment, nth order polynomial function calculation. The coefficients for the nth order polynomial equation defined for various pressure measurement ranges are given in the following table:

For Non-Linear Analog Output voltage range of **0.375 to 2.842 volts**, use this table.

Coefficients for $y(x) = a + bx + cx^2 + dx^3 + ex^4 + fx^5$	
a	-0.02585
b	0.03767
c	0.04563
d	0.1151
e	-0.04158
f	0.008738

For Non-Linear Analog Output voltage range of **2.842 to 4.945 volts**, use this table.

Coefficients for $y(x) = \frac{a + cx + ex^2}{1 + bx + dx^2 + fx^3}$	
a	0.1031
b	-0.3986
c	-0.02322
d	0.07438
e	0.07229
f	-0.006866

For Non-Linear Analog Output voltage range of **4.94 to 5.659 volts**, use this table.

Coefficients for $y(x) = \frac{a + cx}{1 + bx + dx^2}$	
a	100.624
b	-0.37679
c	-20.5623
d	0.0348656

Where $y(x)$ = pressure in Torr, x = measured analog output in volts

Example: Measured analog output voltage is 0.3840 V.

From first table shown above use equation:

$$y(x) = a + bx + cx^2 + dx^3 + ex^4 + fx^5$$

X = 0.3840 volts

A = -0.02585, b=0.03767, c=0.04563, d=0.1151, e=-0.04158, f=0.008738

$y(x)$ = Pressure = 1.0E-03 Torr

The equations listed above are used to calculate the non-linear voltage outputs for N₂/air shown in the table below. Non-linear voltage outputs for various other gases are also shown in the same table.

Non-Linear analog output for selected gases - Engineering units in Torr/mTorr

True Total Pressure	N ₂	Ar	He	O ₂	CO ₂	Kr	Freon12	Freon22	D ₂	Ne	CH ₄
0 mTorr	0.3751	0.3750	0.3750	0.3750	0.3750	0.3750	0.3750	0.3750	0.3750	0.3750	0.3750
0.1 mTorr	0.3759	0.3757	0.3755	0.3760	0.3760	0.3755	0.3760	0.3760	0.3760	0.3757	0.3766
0.2 mTorr	0.3768	0.3760	0.3765	0.3770	0.3770	0.3768	0.3780	0.3780	0.3770	0.3763	0.3780
0.5 mTorr	0.3795	0.3780	0.3790	0.3800	0.3810	0.3772	0.3820	0.3810	0.3810	0.3782	0.3825
1 mTorr	0.3840	0.3810	0.3820	0.3840	0.3850	0.3790	0.3880	0.3880	0.3860	0.3810	0.3896
2 mTorr	0.3927	0.3870	0.3890	0.3920	0.3950	0.3840	0.4010	0.4000	0.3960	0.3880	0.4030
5 mTorr	0.4174	0.4030	0.4090	0.4170	0.4120	0.3950	0.4370	0.4320	0.4250	0.4050	0.4380
10 mTorr	0.4555	0.4290	0.4410	0.4530	0.4620	0.4150	0.4880	0.4800	0.4700	0.4330	0.4920
20 mTorr	0.5226	0.4770	0.4970	0.5210	0.5360	0.4510	0.5810	0.5660	0.5490	0.4840	0.5840
50 mTorr	0.6819	0.5950	0.6370	0.6790	0.7050	0.5440	0.7780	0.7640	0.7270	0.6080	0.7960
100 mTorr	0.8780	0.7450	0.8140	0.8680	0.9000	0.6680	1.0090	0.9900	0.9440	0.7680	1.0530
200 mTorr	1.1552	0.9620	1.0680	1.1410	1.1790	0.8470	1.3150	1.2910	1.2650	1.0020	1.3920
500 mTorr	1.6833	1.3860	1.5890	1.6640	1.6680	1.1940	1.8260	1.8050	1.9140	1.4690	2.0140
1 Torr	2.2168	1.8180	2.1640	2.1950	2.1720	1.5360	2.2570	2.2470	2.6030	1.9760	2.6320
2 Torr	2.8418	2.3330	2.9390	2.8140	2.6950	1.9210	2.6470	2.6660	3.5080	2.6310	3.3130
5 Torr	3.6753	3.0280	4.3870	3.6720	3.3160	2.4290	3.0290	3.0900	5.0590	3.7150	
10 Torr	4.2056	3.4800	5.7740	4.2250	3.6700	2.7340	3.2040	3.3300	6.3610	4.6050	4.6990
20 Torr	4.5766	3.8010	7.3140	4.6200	3.9030	2.9660	3.3080	3.4140		5.4060	5.1720
50 Torr	4.8464	4.0370		4.9160	4.0710	3.0750	3.4300	3.5090		6.1590	5.5830
100 Torr	4.9449	4.1220		5.0260	4.1540	3.1340	3.6180	3.6600		6.4830	5.7200
200 Torr	5.0190	4.1920		5.1060	4.3360	3.2690	3.8270	3.8830		6.6610	5.8600
300 Torr	5.1111	4.2830		5.2000	4.5020	3.3840	3.9380	4.0050		6.7260	
400 Torr	5.2236	4.3860		5.3150	4.6210	3.4660	4.0160	4.0880		6.7670	6.1030
500 Torr	5.3294	4.4770		5.4220	4.7080	3.5260	4.0760	4.1510		6.8030	
600 Torr	5.4194	4.5500		5.5150	4.7750	3.5730	4.1240	4.2030		6.8430	6.3420
700 Torr	5.4949	4.6110		5.5920	4.8300	3.6130	4.1660	4.2470		6.8900	
760 Torr	5.5340	4.6430		5.6330	4.8600	3.6320	4.1900	4.2710		6.9200	
800 Torr	5.5581	4.6630		5.6580	4.8770	3.6450	4.2030	4.2860		6.9420	6.5190
900 Torr	5.6141	4.7060		5.7130	4.9190	3.6740	4.2370	4.3210		7.0000	
1000 Torr	5.6593	4.7450		5.7620	4.9550	3.6900	4.2700	4.3540		7.0560	6.6420

Values listed under each gas type are in volts.

Note: By design, these values are identical to the outputs from MKS Instruments / Granville-Phillips® Convectron® gauges, Mini-Convectron® modules and controllers so that equivalent units can be interchanged without affecting your process system or software.

An analog output of less than 0.01 volts to near 0 volt indicates a damaged or faulty sensor.

7.2 Non-Linear Analog Output - mbar

Non-Linear analog output for selected gases - Engineering units in mbar

True Pressure	N ₂	Ar	He	O ₂	CO ₂	KR	Freon12	Freon22	D ₂	Ne	CH ₄
0 mbar	0.3751	0.375	0.375	0.375	0.375	0.375	0.375	0.375	0.375	0.375	0.375
.0001 mbar	0.3759	0.3757	0.376	0.376	0.376	0.376	0.376	0.376	0.376	0.3757	0.3766
.0003 mbar	0.3768	0.376	0.377	0.377	0.377	0.377	0.378	0.378	0.377	0.3763	0.378
.0006 mbar	0.3795	0.378	0.379	0.38	0.381	0.377	0.382	0.381	0.381	0.3782	0.3825
.0013 mbar	0.384	0.381	0.382	0.384	0.385	0.379	0.388	0.388	0.386	0.381	0.3896
.0027 mbar	0.3927	0.387	0.389	0.392	0.395	0.384	0.401	0.4	0.396	0.388	0.403
.0067 mbar	0.4174	0.403	0.409	0.417	0.412	0.395	0.437	0.432	0.425	0.405	0.438
.0133 mbar	0.4555	0.429	0.441	0.453	0.462	0.415	0.488	0.48	0.47	0.433	0.492
.0266 mbar	0.5226	0.477	0.497	0.521	0.536	0.451	0.581	0.566	0.549	0.484	0.584
.0660 mbar	0.6819	0.595	0.637	0.679	0.705	0.544	0.778	0.764	0.727	0.608	0.796
0.13 mbar	0.878	0.745	0.814	0.868	0.9	0.668	1.009	0.99	0.944	0.768	1.053
0.26 mbar	1.1552	0.962	1.068	1.141	1.179	0.847	1.315	1.291	1.265	1.002	1.392
0.66 mbar	1.6833	1.386	1.589	1.664	1.668	1.194	1.826	1.805	1.914	1.469	2.014
1.33 mbar	2.2168	1.818	2.164	2.195	2.172	1.536	2.257	2.247	2.603	1.976	2.632
2.66 mbar	2.8418	2.333	2.939	2.814	2.695	1.921	2.647	2.666	3.508	2.631	3.313
6.66 mbar	3.6753	3.028	4.387	3.672	3.316	2.429	3.029	3.09	5.059	3.715	
13.3 mbar	4.2056	3.48	5.774	4.225	3.67	2.734	3.204	3.33	6.361	4.605	4.699
26.6 mbar	4.5766	3.801	7.314	4.62	3.903	2.966	3.308	3.414		5.406	5.172
66.6 mbar	4.8464	4.037		4.916	4.071	3.075	3.43	3.509		6.159	5.583
133 mbar	4.9449	4.122		5.026	4.154	3.134	3.618	3.66		6.483	5.72
266 mbar	5.019	4.192		5.106	4.336	3.269	3.827	3.883		6.661	5.86
400 mbar	5.1111	4.283		5.2	4.502	3.384	3.938	4.005		6.726	
533 mbar	5.2236	4.386		5.315	4.621	3.466	4.016	4.088		6.767	6.103
666 mbar	5.3294	4.477		5.422	4.708	3.526	4.076	4.151		6.803	
800 mbar	5.4194	4.55		5.515	4.775	3.573	4.124	4.203		6.843	6.342
933 mbar	5.4949	4.611		5.592	4.83	3.613	4.166	4.247		6.89	
1010 mbar	5.534	4.643		5.633	4.86	3.632	4.19	4.271		6.92	
1060 mbar	5.5581	4.663		5.658	4.877	3.645	4.203	4.286		6.942	6.519
1190 mbar	5.6141	4.706		5.713	4.919	3.674	4.237	4.321		7	
1330 mbar	5.6593	4.745		5.762	4.955	3.69	4.270	4.354		7.056	6.642

Values listed under each gas type are in volts.

Note: By design, these values are identical to the outputs from MKS Instruments / Granville-Phillips® Convectron® gauges, Mini-Convectron® modules and controllers so that equivalent units can be interchanged without affecting your process system or software.

An analog output of less than 0.01 volts to near 0 volt indicates a damaged or faulty sensor.

7.3 Log-Linear Analog Output - Torr

Log-Linear analog output for selected gases - Engineering units in Torr

True Pressure (Torr)	N ₂	Ar	He	O ₂	CO ₂	Kr	Freon12	Freon22	D ₂	Ne	CH ₄
0.0001	1.000	1.000	1.000	1.000	1.000	1.000	1.000	1.000	1.000	1.000	1.000
0.0002	1.301	1.301	1.301	1.301	1.301	1.301	1.301	1.301	1.301	1.301	1.301
0.0005	1.699	1.699	1.699	1.699	1.699	1.477	1.699	1.699	1.699	1.699	1.699
0.0010	2.000	1.845	1.903	2.000	2.041	1.602	2.176	2.176	2.114	1.845	2.230
0.0020	2.301	2.146	2.204	2.301	2.362	2.000	2.491	2.491	2.380	2.176	2.519
0.0050	2.699	2.519	2.602	2.699	2.643	2.362	2.881	2.845	2.778	2.544	2.886
0.0100	3.000	2.820	2.908	2.987	3.041	2.681	3.167	3.130	3.083	2.851	3.185
0.0200	3.301	3.117	3.207	3.297	3.346	2.978	3.476	3.435	3.386	3.149	3.483
0.0500	3.699	3.511	3.607	3.692	3.740	3.371	3.860	3.839	3.778	3.542	3.888
0.1000	4.000	3.808	3.914	3.988	4.029	3.670	4.155	4.134	4.083	3.845	4.201
0.2000	4.301	4.100	4.217	4.288	4.322	3.960	4.439	4.418	4.398	4.149	4.498
0.5000	4.699	4.494	4.638	4.687	4.689	4.336	4.786	4.774	4.837	4.555	4.893
1.0000	5.000	4.778	4.973	4.987	4.978	4.602	5.021	5.017	5.190	4.872	5.204
2.0000	5.301	5.057	5.346	5.288	5.233	4.845	5.210	5.220	5.616	5.201	5.522
5.0000	5.699	5.389	6.130	5.697	5.524	5.107	5.389	5.418	7.391	5.719	5.877
10.0000	6.000	5.602	8.041	6.013	5.696	5.250	5.471	5.530	8.041	6.332	6.446
20.0000	6.301	5.763	8.041	6.348	5.819	5.360	5.521	5.571	8.041	7.766	7.550
50.0000	6.699	5.895	8.041	6.890	5.915	5.410	5.579	5.617	8.041	8.041	7.925
100.0000	7.000	5.946	8.041	7.320	5.966	5.438	5.670	5.691	8.041	8.041	8.041
200.0000	7.301	5.991	8.041	7.470	6.090	5.521	5.777	5.808	8.041	8.041	8.041
300.0000	7.477	6.053	8.041	7.580	6.228	5.555	5.838	5.876	8.041	8.041	8.041
400.0000	7.602	6.130	8.041	7.686	6.350	5.595	5.883	5.925	8.041	8.041	8.041
500.0000	7.699	6.207	8.041	7.781	6.458	5.624	5.918	5.964	8.041	8.041	8.041
600.0000	7.778	6.274	8.041	7.863	6.561	5.647	5.947	5.998	8.041	8.041	8.041
700.0000	7.845	6.338	8.041	7.934	6.664	5.667	5.974	6.029	8.041	8.041	8.041
760.0000	7.881	6.375	8.041	7.974	6.732	5.677	5.989	6.045	8.041	8.041	8.041
800.0000	7.903	6.400	8.041	7.999	6.774	5.685	5.998	6.057	8.041	8.041	8.041
900.0000	7.954	6.455	8.041	8.041	6.900	5.698	6.021	6.079	8.041	8.041	8.041
1000.0000	8.000	6.512	8.041	8.041	7.045	5.706	6.045	6.104	8.041	8.041	8.041

Values listed under each gas type are in volts.

The log-linear output signal and pressure in the table above are related by the following formulas:

$$P = 10^{(V - 5)} \quad V = \log_{10}(P) + 5$$

where P is the pressure in Torr, and V is the output signal in volts.

An analog output of less than 0.01 volts to near 0 volt indicates a damaged or faulty sensor.

The chart on the following page shows the graphical results of the table and formulas given above for nitrogen. True pressure (N₂) is plotted on the X-axis with a log scale. The output signal is plotted on the Y-axis on a linear scale.

Note - when using the units of pascals, the same equation of $P = 10^{(V - 5)}$ listed above applies. This results in a log-linear analog output range of about 3.00 Vdc at .01 pascals (Pa) and 10.12 Vdc at 133 KPa.

Log-Linear Analog Output Voltage vs. Pressure

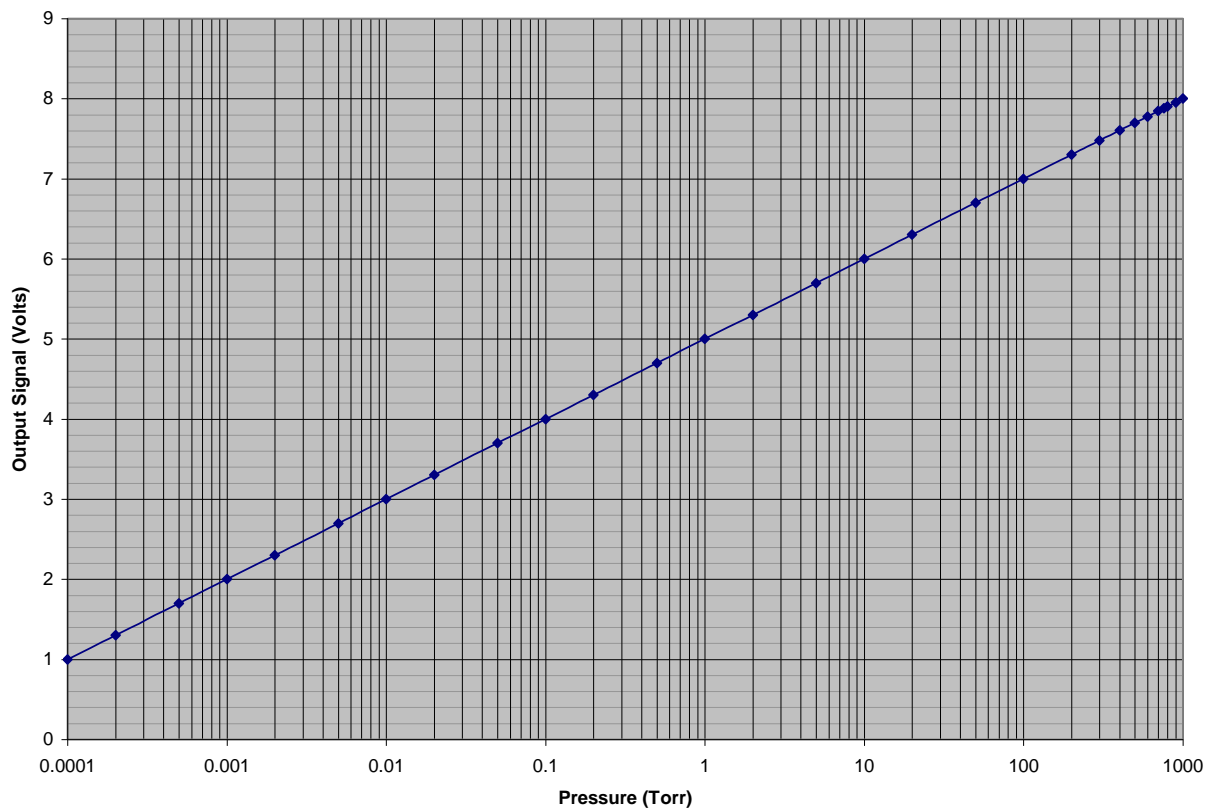

Chart of the calculated pressures using the formulas and data for the log-linear output signal for nitrogen from the previous page.

7.4 Log-Linear Analog Output - mbar

Log-Linear analog output for selected gases - Engineering units in mbar

True Pressure (mbar)	N ₂	Ar	He	O ₂	CO ₂	KR	Freon12	Freon22	D ₂	Ne	CH ₄
0.0001	1.000	1.000	1.000	1.000	1.000	1.000	1.000	1.000	1.000	1.000	1.000
0.0002	1.301	1.301	1.301	1.301	1.301	1.301	1.301	1.301	1.301	1.301	1.301
0.0005	1.699	1.699	1.699	1.699	1.699	1.523	1.699	1.699	1.699	1.699	1.699
0.0010	2.000	1.903	1.938	2.000	2.028	1.668	2.125	2.125	2.080	1.903	2.167
0.0020	2.301	2.146	2.204	2.301	2.355	1.970	2.487	2.487	2.392	2.166	2.523
0.0050	2.699	2.524	2.602	2.699	2.672	2.370	2.883	2.855	2.778	2.551	2.893
0.0100	3.000	2.820	2.908	2.991	3.012	2.675	3.172	3.136	3.082	2.849	3.186
0.0200	3.301	3.188	3.208	3.294	3.345	2.979	3.473	3.434	3.385	3.150	3.484
0.0500	3.699	3.512	3.607	3.693	3.741	3.372	3.863	3.837	3.779	3.543	3.886
0.1000	4.000	3.809	3.928	3.989	4.033	3.671	4.157	4.136	4.082	3.844	4.197
0.2000	4.301	4.103	4.217	4.288	4.325	3.963	4.445	4.424	4.393	4.148	4.500
0.5000	4.699	4.495	4.634	4.686	4.696	4.341	4.798	4.783	4.828	4.553	4.893
1.0000	5.000	4.784	4.962	4.987	4.982	4.614	5.044	5.037	5.174	4.867	5.201
2.0000	5.301	5.064	5.324	5.288	5.249	4.865	5.250	5.255	5.579	5.192	5.517
5.0000	5.699	5.404	6.070	5.695	5.550	5.141	5.447	5.471	7.288	5.696	5.877
10.0000	6.000	5.633	8.125	6.008	5.743	5.309	5.556	5.602	8.125	6.252	6.374
20.0000	6.301	5.815	8.125	6.337	5.886	5.433	5.621	5.675	8.125	7.608	7.409
50.0000	6.699	5.969	8.125	6.862	6.002	5.514	5.680	5.722	8.125	8.125	7.930
100.0000	7.000	6.045	8.125	7.282	6.065	5.548	5.751	5.780	8.125	8.125	8.125
200.0000	7.301	6.093	8.125	7.526	6.157	5.606	5.851	5.877	8.125	8.125	8.125
300.0000	7.477	6.131	8.125	7.625	6.253	5.654	5.918	5.950	8.125	8.125	8.125
400.0000	7.602	6.178	8.125	7.705	6.353	5.679	5.962	6.000	8.125	8.125	8.125
500.0000	7.699	6.237	8.125	7.786	6.448	5.710	5.996	6.038	8.125	8.125	8.125
600.0000	7.778	6.295	8.125	7.861	6.532	5.734	6.025	6.070	8.125	8.125	8.125
700.0000	7.845	6.349	8.125	7.928	6.611	5.754	6.050	6.097	8.125	8.125	8.125
760.0000	7.881	6.380	8.125	7.965	6.658	5.765	6.063	6.112	8.125	8.125	8.125
800.0000	7.903	6.399	8.125	7.988	6.687	5.772	6.072	6.122	8.125	8.125	8.125
900.0000	7.954	6.488	8.125	8.042	6.766	5.787	6.092	6.146	8.125	8.125	8.125
1000.0000	8.000	6.494	8.125	8.092	6.847	5.799	6.111	6.167	8.125	8.125	8.125
1100.0000	8.041	6.539	8.125	8.125	6.936	5.812	6.128	6.187	8.125	8.125	8.125
1200.0000	8.079	6.580	8.125	8.125	7.028	5.822	6.146	6.204	8.125	8.125	8.125
1300.0000	8.114	6.624	8.125	8.125	7.140	5.828	6.164	6.222	8.125	8.125	8.125
1333.0000	8.125	6.636	8.125	8.125	7.169	5.830	6.169	6.228	8.125	8.125	8.125

Values listed under each gas type are in volts.

The log-linear output signal and pressure in the table above are related by the following formulas:

$$P = 10^{(V-5)} \quad V = \log_{10}(P) + 5$$

Where P is the pressure in mbar, and V is the output signal in volts.

An analog output of less than 0.01 volts to near 0 volt indicates a damaged or faulty sensor.

The chart on the following page shows the graphical results of the table and formulas given above for nitrogen.

True pressure (N₂) is plotted on the X-axis with a log scale. The output signal is plotted on the Y-axis on a linear scale.

Note - when using the units of pascals, the same equation of $P = 10^{(V-5)}$ listed above applies. This results in a log-linear analog output range of about 3.00 Vdc at .01 pascals (Pa) and 10.12 Vdc at 133 KPa.

Log-Linear Analog Output Voltages vs Pressure (mbar)

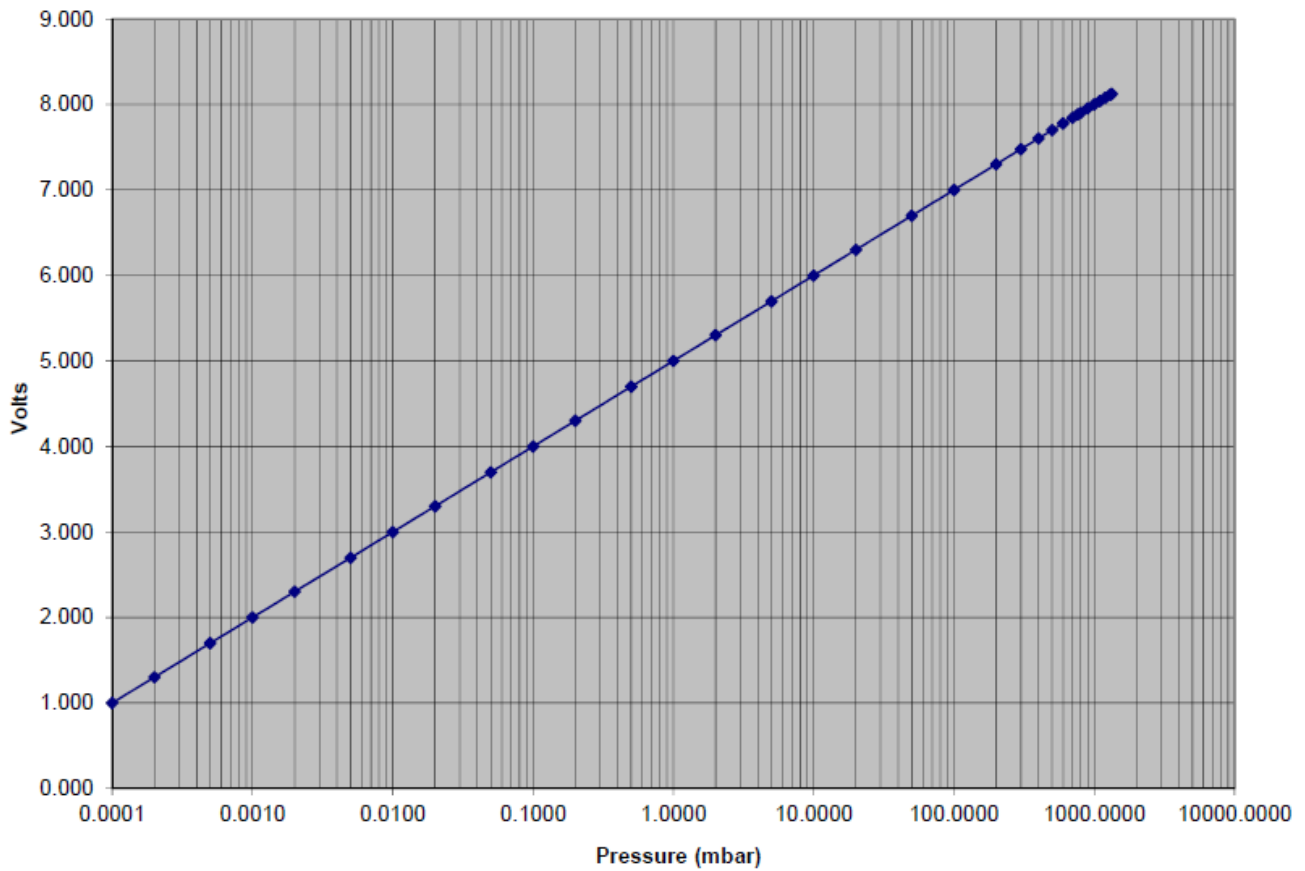

Chart of the calculated pressures using the formulas and data for the log-linear output signal for nitrogen from the previous page.

7.5 Linear Analog Output

The CVM201 analog output may be setup to provide a 0-10 Vdc output signal that has a direct linear relationship to the displayed pressure. When preparing to setup and process the linear analog output signal, first define the following parameters that you will program into the CVM201.

- Minimum measured pressure (for the defined analog output range)
- Minimum output voltage desired (proportional to the minimum pressure)
- Maximum measured pressure (for the analog output signal range)
- Maximum output voltage desired (proportional to maximum pressure)

Constructing a table of these parameters may be useful in documenting the relationship of displayed pressure to the analog output voltage. For example, the following table is representative of a typical setup where;

Min P = 1.00E-03 Torr Min Voltage = 0.01 Volts

Max P = 1.00 Torr Max Voltage = 10 V

<u>Linear Analog Output Voltage - volts</u>	<u>Measured (Displayed) Pressure - torr</u>
0.01	1.00E-03
0.10	1.00E-02
1.00	1.00E-01
10.00	1.00E+00

It is recommended that the *Linear* output signal be setup such that the range covers, at most, 3 decades of pressure change. For example, if the minimum pressure selected is 1 mtorr (1.00E-03 torr) with a corresponding minimum voltage output of 0.01 volts, then the maximum pressure selected to correspond to a maximum voltage of 10.0 volts should not exceed 1.00 torr.

Doing this is considered best practice when using this type of analog output signal with the CVM201.

If your application requires the analog output voltage to cover a pressure range exceeding three decades, then consider using the log-linear or non-linear analog output.

8 RS485 / RS232 serial communications

8.1 Device Specific Serial Communication Info

The standard CVM201 model provides RS232 / RS485 serial communications. The following information and the RS485 / RS232 command protocol summary listed on the next page should be used to set serial communications with the device.

1. Default settings are 19,200 baud rate, 8 data bits, No Parity, 1 stop bit [Factory default; 19,200, 8, N, 1].
2. The baud rate can be set to different values through the serial interface command set or the front panel push buttons.
3. The parity can be changed only through the serial interface command set and the number of data bits will change according to the parity selected.
4. The stop bit is always 1.
5. All Responses are 13 characters long.
6. xx is the address of the device (00 thru FF).
7. <CR> is a carriage return.
8. _ is a space.
9. The 'z' in the set or read trip point commands is a + or -. The plus is the 'turns on below' point and the minus is the 'turns off above' point.
10. All commands sent to the module start with a '#' character, and all responses from the module start with a '*' character.
11. This protocol was designed to be 100% compatible with the Granville-Phillips® Mini-Convectron®.
12. A valid address must be used even in RS232 commands [Factory default = 1].

8.2 RS485 / RS232 Command Protocol Summary

COMMAND	BRIEF DESCRIPTION	COMMAND SYNTAX	RESPONSE
READ	Read the current pressure in Torr	#xxRD<CR> (eg: #01RD<CR>)	*xx_y.yyEzzy<CR> (eg: *01_7.60E+02<CR>)
SET ADDR OFFSET & ADDRESS	Set the communications (RS485) address offset (upper nibble) and Address ⁽¹⁾	#xxSAXx<CR> (eg: #01SA20<CR>) In example #01SA20 above ; 2=ADDR OFFSET, 0= ADDRESS	*xx_PROGM_OK<CR>
SET SPAN	Set the span or atmosphere calibration point	#xxTSy.yyEzzy<CR> (eg: #01TS7.60E+02)	*xx_PROGM_OK<CR>
SET ZERO	Set the zero or vacuum calibration point	#xxTZy.yyEzzy<CR> (eg: #01TZ0.00E-04<CR>)	*xx_PROGM_OK<CR>
SET TRIP POINT #1	Set the 'turns on below' pressure point for relay #1 and set the 'turns off above' pressure point for relay #1. ⁽²⁾	#xxSLzy.yyEzzy<CR> (eg: #01SL+4.00E+02<CR>) (eg: #01SL-5.00E+02<CR>)	*xx_`PROGM_OK<CR>
SET TRIP POINT #2	Set the 'turns on below' pressure point for relay #2 and set the 'turns off above' pressure point for relay #2. ⁽²⁾	#xxSHzy.yyEzzy<CR> (eg: #01SH+4.00E+02<CR>) (eg: #01SH-5.00E+02<CR>)	*xx_PROGM_OK<CR>
READ TRIP POINT #1	Read the 'turns on below' pressure point for relay #1 and read the 'turns off above' pressure point for relay #1.	#xxRLz<CR> (eg: #01RL+<CR>) (eg: #01RL-<CR>)	*xx_y.yyEzzy<CR> (eg: *01_7.60E+02<CR>)
READ TRIP POINT #2	Read the 'turns on below' pressure point for relay #2 and read the 'turns off above' pressure point for relay #2.	#xxRHZ<CR> (eg: #01RH+<CR>) (eg: #01RH-<CR>)	*xx_y.yyEzzy<CR> (eg: *01_7.60E+02<CR>)
READ SW VERSION	Read the revision number of the firmware.	#xxVER<CR> (eg: #01VER<CR>)	*xx_mmmnnv-vv (eg: *0105041-00)
SET FACTORY DEFAULTS	Force unit to return ALL settings back to the way the factory programmed them before shipment. ⁽¹⁾	#xxFAC<CR> (eg: #01FAC<CR>)	*xx_PROGM_OK<CR>
SET BAUD RATE	Set the communications baud rate for RS485 and RS232. ⁽¹⁾	#xxSByyyy<CR> (eg: #01SB19200<CR>)	*xx_PROGM_OK<CR>
SET NO PARITY	Set the communications to NO parity, 8 bits for the RS485 and RS232. ⁽¹⁾	#xxSPN<CR> (eg: #01SPN<CR>)	*xx_PROGM_OK<CR>
SET ODD PARITY	Set the communications to ODD parity, 7 bits for the RS485 and RS232. ⁽¹⁾	#xxSPO<CR> (eg: #01SPO<CR>)	*xx_PROGM_OK<CR>
SET EVEN PARITY	Set the communications to EVEN parity, 7 bits for the RS485/ RS232. ⁽¹⁾	#xxSPE<CR> (eg: #01SPE<CR>)	*xx_PROGM_OK<CR>
RESET	Reset the device. (required to complete some of the commands.)	#xxRST<CR> (eg: #01RST<CR>)	No response

(1) Commands marked with a ⁽¹⁾ under the “BRIEF DESCRIPTION” column will not take effect until after RESET command is sent or power is cycled. This protocol was designed to be 100% compatible with the Granville-Phillips® Mini-Convectron®.

(2) Commands marked with a ⁽²⁾ under the “BRIEF DESCRIPTION” column will not take effect until after ADDR OFFSET & ADDRESS command is resent followed by the RESET command.

9 Service

9.1 Calibration

Every InstruTech module is calibrated prior to shipment using nitrogen (N₂). However, you can calibrate the instrument by adjusting zero (vacuum) and span (atmosphere) using the procedure described previously in [section 4.3](#) titled “Programming”. Zero and span (atmosphere) calibration affect the displayed value and the output signal. Zero calibration optimizes performance of the gauge when operating at a low pressure range of 1.00 x 10⁻⁴ Torr to 1.00 x 10⁻³ Torr. If your minimum operating pressure is higher than 1.00 x 10⁻³ Torr, it is not normally necessary to perform calibration at zero and thus span calibration should be adequate. If you are able to evacuate your system to below 1.00 x 10⁻⁴ Torr, it is always a good practice to check and set zero if necessary. This will also improve performance in cases where gauge contamination is causing higher readings than 1.00 x 10⁻⁴ Torr even though the system has been evacuated to below 1.00 x 10⁻⁴ Torr. Care should be exercised when using gases other than nitrogen (N₂).

9.2 Maintenance

In general, maintenance is not required for your InstruTech module. Periodic performance checks may be done by comparing the gauge to a known reference standard.

9.3 Troubleshooting

Indication	Possible Cause	Possible Solution
Display is off / blank	No power	Check power supply & power cable
Readings appear very different from expected pressure	The process gas is different from the gas used to calibrate the CVM201 Module has not been calibrated or has been calibrated incorrectly	Correct readings for different gas thermal conductivity. See section 5 on using the gauge with different gases Check that zero and span are adjusted correctly
Readings are noisy or erratic	Loose cables or connections Contamination Vibration	Check and tighten connections Inspect gauge for signs of contamination such as particles, deposits, discoloration on gauge inlet. Return to factory for possible cleaning Ensure gauge is not mounted where excessive vibration is present
Gauge cannot be calibrated - zero and span can't be adjusted	Contamination Sensor failure for other cause	Return to factory for possible cleaning Replace sensor inside CVM201 module
Setpoint does not actuate	Incorrect setup	Check setpoint setup
Display shows “Sensor Bad”	Sensor wire damaged	Replace sensor inside CVM201 module
Display shows “overpressure”	System pressure over 1000 Torr Faulty electronics	Reduce pressure Repair or replace CVM201 electronics
Atmospheric pressure reads too high and can't be set to correct value	Contamination Sensor wire damaged	Return to factory for possible cleaning Replace sensor inside CVM201 module
Atmospheric pressure reads too low and can't be set to correct value	Sensor wire damaged Contamination	Replace sensor inside CVM201 module Return to factory for possible cleaning

9.4 Contamination

The most common cause of all vacuum gauge failures is contamination of the sensor. Noisy or erratic readings, the inability to set zero or atmosphere and total gauge failure, are all possible indications of gauge contamination.

Contamination can be generally characterized as either:

- A) a reaction of process gases with sensor elements, or
- B) an accumulation of material on the sensor elements. Sensors that fail due to chemical reaction are generally not salvageable. Sensors that fail due to condensation, coatings, or particles may possibly be restored by cleaning.

A) Reactive Gases

If process gases react with the materials of construction of the sensor, the result is corrosion and disintegration of the sensor over time. The chemistry of the gases used for plasma etching and other reactive semiconductor processes are examples where this failure mode is possible. In this case, cleaning can't solve the problem because the sensor has been destroyed. The sensor or module must be replaced.

If you experience this failure mode quickly or frequently, you should consider a different vacuum gauge for your application. Thermal vacuum gauges may be available with different sensor materials that are not as reactive with your particular process gases. The standard gold plated tungsten sensor used in the InstruTech convection gauge is offered for use with air and inert gases such as N₂, argon, etc. InstruTech also offers platinum sensors for applications not compatible with gold plated tungsten.

There is no material that is universally chemical resistant; your choice of vacuum gauge (as well as all other vacuum components) should take into consideration the potential reactions between your process gases and the materials of construction. Consider what effect water vapor will have when combined with your process gases because a finite amount of water will enter the chamber during venting to atmosphere with air.

B) Oil, Condensation, Coatings, and Particles

If the failure is due to an accumulation of material in the gauge, we may be able to restore your gauge or module by cleaning. Contamination may be as simple as condensed water, or as difficult as solid particles.

Oils and hydrocarbons: Exposure of the gauge internal surfaces to oils and hydrocarbons can result in sensor contamination. Some of these types of contamination may be removed by cleaning the gauge. If there is the possibility of oil back streaming from wet vacuum pumps, it is recommended that a filter or trap be installed to prevent contamination of components of your vacuum system.

Condensation: Some gases (such as water vapor) can condense on sensor surfaces, forming a liquid coating that changes the rate at which heat is removed from the sensor (which changes the calibration). The sensor can often be restored simply by pumping on the gauge between process cycles. A dry N₂ purge will help speed up drying, or the gauge may be gently heated provided temperature doesn't exceed the specified limit of 40 °C, operating.

Coatings: Some gases can condense on sensor surfaces, forming a solid coating, which changes the rate at which heat is removed from the sensor. Some of these coatings may be removed by cleaning the gauge.

Particles: Particles generated by the process may enter the gauge during the process cycle or during the venting cycle. The result is interference with heat removal from the sensor. In this case, cleaning may be able to remove particles from the gauge. However, particulate contamination is the most difficult to remove as particles can become stubbornly trapped inside the gauge. In some processes, solid particles are created during the process throughout the chamber including inside the gauge. Particles tend to form on cooler surfaces such as in a gauge at room temperature. You may slow down the build-up of particles in the gauge by keeping the gauge warm (within specified limits) during the process cycle.

Particles in the process chamber may be swept into the gauge during the vent cycle. The CVM201 has a screen built into the gauge port to help keep the largest particles out of the gauge. In very dirty applications, or where particles are small enough to get through the screen, an additional filter installed on the inlet may help prolong the gauge life.

In some vacuum processes, desorbed and sputtered materials from the process may enter vacuum components connected to the process vacuum chamber by line-of-sight transport, especially under high vacuum conditions, i.e., in the molecular flow regime. To prevent materials that may be transported via line-of-sight momentum from entering your vacuum gauge or other components, it is advisable to install some form of apparatus that will block the line-of-sight. In many cases a simple 90° elbow may help prevent or reduce the transport of particles from entering your vacuum gauge.

In the event of gauge contamination please contact the factory to return the gauge for possible cleaning if the gauge has not been exposed to hazardous materials.

9.5 Module and sensor replacement

The CVM201 module is factory calibrated for the specific sensor (gauge tube) installed in it. If the sensor inside the module fails for any reason, the CVM201 module should be replaced or returned to the factory for replacement of the sensor and recalibration of the complete CVM201 module. If you prefer to have your sensor replaced and the module recalibrated, contact the factory for return authorization, as described below.

10 Factory Service and Support

If you need help setting up, operating, troubleshooting, or obtaining a return materials authorization number (RMA number) to return the module for diagnosis, please contact us during normal business hours (8:00am to 5:00pm Mountain time) Monday through Friday, at 303-651-0551. Or e-mail us at support@instrutechinc.com.

For the safety of our employees, you must download, complete and submit a material disclosure form from our website at www.instrutechinc.com Please use this form to provide a history of the gauge detailing what gases have been used. We cannot accept gauges that have been exposed to hazardous materials.

11 Warranty

SELLER warrants that its products are free of defects in workmanship and material and fit for the uses set forth in SELLER's catalog or product specifications, under the normal use and service for which they are intended.

The entire warranty obligation of SELLER is for the repair or replacement, at SELLER's option, of products or parts (examination of which shall disclose to SELLER's satisfaction that it is defective) returned, to SELLER's plant, properly identified within twenty four (24) months (unless otherwise noted) after the date of shipment from InstruTech Plant. BUYER must obtain the approval of SELLER and a return authorization number prior to shipment.

Alteration or removal of serial numbers or other identification marks renders this warranty void. The warranty does not apply to products or components which have been abused, altered, operated outside of the environmental specifications of the product, improperly handled or installed, or units which have not been operated in accordance with SELLER's instructions. Furthermore the warranty does not apply to products that have been contaminated, or when the product or part is damaged during the warranty period due to causes other than ordinary wear and tear to the product including, but not limited to, accidents, transportation, neglect, misuse, use of the product for any purpose other than that for which it was designed.

THIS WARRANTY IS EXCLUSIVE AND IN LIEU OF ALL OTHER WARRANTIES, EXPRESS OR IMPLIED, INCLUDING ANY IMPLIED WARRANTY OF MERCHANTABILITY OR FITNESS FOR A PARTICULAR PURPOSE. THIS WARRANTY EXTENDS ONLY IN FAVOR OF THE ORIGINAL BUYER. THE BUYER'S SOLE REMEDY SHALL BE THE REPAIR OR REPLACEMENT, AS IS EXPRESSLY PROVIDED HEREIN, OF ANY WARRANTED DEFECTIVE PRODUCT OR PART, AND UNDER NO CIRCUMSTANCE SHALL SELLER BE LIABLE TO BUYER OR ANYONE ELSE FOR ANY CONSEQUENTIAL DAMAGES TO PERSONS OR PROPERTY, FOR INCIDENTAL DAMAGES OR LOSS OF TIME, FOR ANTICIPATED OR LOST PROFITS, OR ANY OTHER LOSS INCURRED BY THE BUYER RELATED TO THE PRODUCT COVERED BY THIS WARRANTY. THIS EXCLUSIVE REMEDY SHALL NOT BE DEEMED TO HAVE FAILED OF ITS ESSENTIAL PURPOSE SO LONG AS SELLER IS WILLING AND ABLE TO REPAIR OR REPLACE DEFECTIVE PARTS IN THE PRESCRIBED MANNER. THIS LIMITED WARRANTY MAY NOT BE MODIFIED BY SELLER UNLESS SUCH MODIFICATION OR WAIVER IS IN WRITING, EXECUTED BY AN AUTHORIZED OFFICER OF SELLER.



InstruTech®

1475 S. Fordham St
Longmont, CO 80503
USA

Phone +1-303-651-0551

Fax +1-303-678-1754

E-mail info@instrutechinc.com

www.instrutechinc.com