

VGC301 Convection Vacuum Gauge Controller



User Manual

InstruTech, Inc.
1475 S. Fordham St.
Longmont, CO 80503
USA

Phone: +1-303-651-0551
Fax: +1-303-678-1754
E-mail info@instrutechinc.com
www.instrutechinc.com

NOTICE

This User Manual is applicable to the InstruTech® model VGC301 product manufactured with firmware number XXXXX-**11** (last two digits of **11**). See Info screen menu described in [section 4.2](#) of this manual to determine the firmware version of your VGC301. For previous versions of VGC301 User Manuals manufactured with firmware XXXXX-**10** or lower (last two digits of **10** or lower), please go to <http://www.instrutechinc.com/downloads-archived-user-manuals/>.

Copyright © 2012 by InstruTech, Inc.

All rights reserved. No part of this work may be reproduced or transmitted in any form or by any means, electronic or mechanical, including photocopying and recording, or by any information storage or retrieval system, except as may be expressly permitted in writing by InstruTech, Inc.

Printed in the United States of America

Convectron® and Granville-Phillips® are registered trademarks of Brooks Automation, Inc. Chelmsford, MA

Table of Contents

1	Introduction / General Information	3
1.1	Description	3
1.2	Specifications	3
1.3	Dimensions.....	4
1.4	Part Numbers	4
2	Important Safety Information.....	6
2.1	Safety Precautions - General.....	6
2.2	Safety Precautions - Service and operation.....	7
2.3	Electrical Conditions.....	7
2.3.1	Proper Equipment Grounding	7
2.3.2	Electrical Interface and Control	8
2.4	Overpressure and use with hazardous gases	8
2.5	Gases other than Nitrogen / air	8
3	Installation	9
3.1	Mechanical Installation	9
3.2	Electrical Installation.....	10
3.2.1	Grounding	10
3.2.2	Electrical Connections.....	10
4	Setup and Operation.....	12
4.1	User Interface Basics.....	12
4.2	Programming.....	12
4.3	Return to Factory Default Settings	14
5	Using the gauge with different gases	15
6	Display.....	17
6.1	Display - Torr / mTorr.....	17
6.2	Display - mbar	18

7 Analog Output.....19

7.1 Log 1-8; Log-Linear Analog Output Equation & Table - Torr22

7.2 Log 1-8; Log-Linear Analog Output Equation & Table - mbar.....24

7.3 Log 0-7; Log-Linear Analog Output Equation & Table - Torr26

7.4 Log 0-7; Log-Linear Analog Output Equation & Table - mbar.....28

7.5 NONLIN 6V; Non-Linear Analog Output Equations.....30

7.6 NONLIN 6V; Non-Linear Analog Output Table - Torr31

7.7 NONLIN 6V; Non-Linear Analog Output Table - mbar32

7.8 NONLIN 9V; Non-Linear Analog Output Equations & Table33

7.9 LINEAR (0-10 Vdc)35

8 RS485 / RS232 serial communications.....36

8.1 Device Specific Serial Communication Info.....36

8.2 RS485 / RS232 Command Protocol Summary37

9 Service38

9.1 Calibration.....38

9.2 Maintenance38

9.3 Troubleshooting.....38

10 Factory Service and Support.....39

11 Warranty.....39

1 Introduction / General Information

1.1 Description

The VGC301 vacuum gauge controller is a convenient and inexpensive power supply and readout instrument for the InstruTech® CVG101 *Worker Bee™ convection-enhanced* Pirani vacuum gauge sensor or a Granville-Phillips® 275 Convectron®. The 1/8-DIN housing can be used as a bench top, or mounted in a cutout in an instrument panel. The VGC301 is powered by user supplied 12 to 30 Vdc, 2 W, or by the InstruTech PS301 power supply.

Thermal conductivity gauges measure pressure indirectly by sensing the loss of heat from a sensor to the surrounding gases. The higher the pressure of the surrounding gas, the more heat is conducted away from the sensor. Pirani thermal conductivity gauges maintain a sensor (usually a wire) at some constant temperature, and measure the current or power required to maintain that temperature. A standard Pirani gauge has a useful measuring range of about 10^{-4} Torr to 10 Torr. By taking advantage of convection currents that are generated above 1 Torr, *convection-enhanced* Pirani gauges increase the measuring range to just above atmosphere.

The VGC301 signals and relay functions are the same as found on similar convection gauge controllers from other manufacturers. The VGC301 Controller, CVG101 vacuum gauge tube and gauge cable can be directly interchanged with Brooks Automation, Inc. / Granville-Phillips® (GP) 375 or 475 controller, 275 Convectron® gauge and gauge cable (Remote interface, relay and power connectors are different). Various analog output scaling provide signal compatibility with GP controller series 375, 475, the original GP 1/4 DIN 275 Analog Convectron Gauge Controller as well as the Mini-Convectron® module.

1.2 Specifications

measurement range (signal)	1.0×10^{-4} to 1000 Torr / 1.3×10^{-4} to 1333 mbar / 1.3×10^{-2} Pa to 133 kPa
display	Bright OLED, 4 digits, user-selectable Torr, mbar, or Pa, (4 digits from 1100 Torr to 1000 Torr), (3 digits from 999 Torr to 10.0 mTorr), (2 digits from 9.9 mTorr to 1.0 mTorr), (1 digit from 0.9 mTorr to 0.1 mTorr)
display engineering units	Torr, mbar, or Pa - user selectable
display update rate	0.5 sec
weight	9 oz. (250 g)
temperature	operating; 0 to +40 °C storage; -40 to +70 °C
humidity	0 to 95% relative humidity, non-condensing
altitude	operating; 6,560 ft. (2,000 m) max storage; 41,000 ft. (12,500 m) max
analog output (user-selectable)	a) log-linear 0 to 7 Vdc or 1 to 8 Vdc, 1 V/decade, or b) linear 0 to 10 Vdc, or c) non-linear S-curve 0.375 to 5.659 Vdc, or d) non-linear S-curve 0 to 9 Vdc
serial communications	RS232 and 2 wire/4 wire RS485 - ASCII protocol
housing	1/8-DIN panel-mount enclosure (aluminum extrusion)
input power	12-30 Vdc, 2 W
setpoint relays	two single-pole double-throw relays (SPDT) 1 A at 30 Vdc resistive, or ac non-inductive
connectors	gauge: 9-pin D-sub female (mating connector provided as part of the gauge cable) analog output and serial communications interface: 9-pin D-sub male relay outputs: 6-pin pluggable terminal block (mating connector included) power: 2-pin pluggable terminal block (mating connector included)
RF/EMI protection	CE compliant
environmental	RoHS compliant

1.3 Dimensions

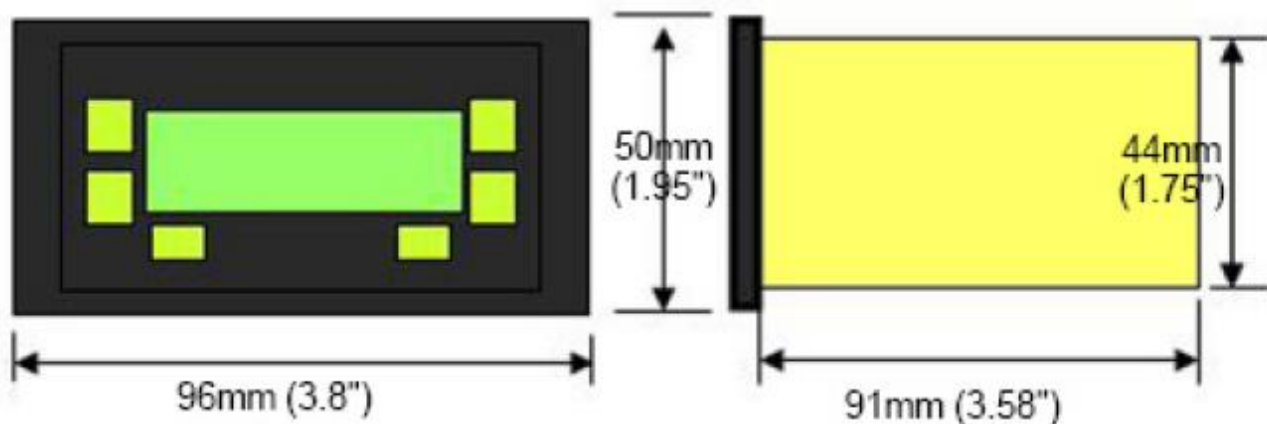

1.4 Part Numbers

	P/N
VGC301 Controller (Power On/Off buttons enabled. Must Push On/Off buttons to turn controller on/off).	VGC301A
VGC301 Controller (Power On/Off buttons disabled. Controller turns on automatically when power is applied).	VGC301B

Optional PS301 Power Supply for VGC301 controller

Input: 100 - 240 Vac, 50-60 Hz

Output: + 24 Vdc

Cable Length: 6 ft. (2 m)



with North American AC Plug



PS301-A

with Universal European AC Plug



PS301-EU

with UK AC Plug



PS301-UK

with China AC Plug



P301-C

with Australian AC Plug



PS301-SP



This variation of the PS301 power supply may be used when an AC plug that is not listed above is required. The conventional IEC60320 AC power entry receptacle allows use with any user supplied AC mains power cord set available worldwide.

PS301-UX

Part Numbers continued -

P/N

Vacuum Gauge Cable

For connecting the CVG101 Worker Bee™ vacuum gauge sensor to the VGC301 controller



10 ft. (3 m):	CB421-1-10F
25 ft. (8 m):	CB421-1-25F
50 ft. (15 m):	CB421-1-50F
over 50 ft. or custom lengths:	Consult Factory

InstruTech CVG101 Worker Bee Convection Vacuum Gauge Sensor



Combination 1/8 in. NPT male - 1/2 in. tube (use 1/8" NPT male or 1/2" O.D. O-ring compression)	CVG101GA
NW16KF	CVG101GB
NW25KF	CVG101GC
NW40KF	CVG101GD
1 1/3 in. Mini-CF / NW16CF Mini-Conflat®	CVG101GE
2 3/4 in. CF / NW35CF Conflat®	CVG101GF
1/4 in. Cajon® 4VCR® female	CVG101GG
1/2 in. Cajon® 8VCR® female	CVG101GH

2 Important Safety Information

InstruTech has designed and tested this product to provide safe and reliable service, provided it is installed and operated within the *strict safety guidelines provided in this manual*. **Please read and follow all warnings and instructions.**



To avoid serious injury or death, follow the safety information in this document. Failure to comply with these safety procedures could result in serious bodily harm, including death, and or property damage.

Failure to comply with these warnings violates the safety standards of installation and intended use of this instrument. InstruTech, Inc. disclaims all liability for the customer's failure to comply with these instructions.

Although every attempt has been made to consider most possible installations, InstruTech cannot anticipate every contingency that arises from various installations, operation, or maintenance of the controller. If you have any questions about the safe installation and use of this product, please contact InstruTech.

2.1 Safety Precautions - General

Hazardous voltages are present with this product during normal operation. The product should never be operated with the enclosure removed unless equivalent protection of the operator from accidental contact with hazardous internal voltages is provided.

 **WARNING!** There are no operator serviceable parts or adjustments inside the product enclosure. Refer servicing to service trained personnel.

Do not modify this product or substitute any parts without authorization of qualified InstruTech service trained personnel. Return the product to an InstruTech qualified service and repair center to ensure that all safety features are maintained. Do not use this product if unauthorized modifications have been made.

 **WARNING!** Source power must be removed from the product prior to performing any servicing.

After servicing this product, ensure that all safety checks are made by a qualified service person. When replacement parts are required, ensure that the parts are specified by InstruTech, Inc. Substitutions of non-qualified parts may result in fire, electric shock or other hazards. Use of unauthorized parts or modifications made to this product will void the warranty.

To reduce the risk of fire or electric shock, do not expose this product to rain or moisture. These products are not waterproof and careful attention must be paid to not spill any type of liquid onto these products. Do not use these products if they have been damaged. Immediately contact InstruTech, Inc. to arrange return of the product if it is damaged.

Due to the possibility of corrosion when used in certain environmental conditions, it is possible that the product's safety could be compromised over time. It is important that the product be periodically inspected for sound electrical connections and equipment grounding. Do not use if the equipment grounding or electrical insulation has been compromised.

2.2 Safety Precautions - Service and operation

Ensure the enclosure of the VGC301 is connected directly to a good quality earth ground.

Ensure that the vacuum port on which the CVG101 vacuum gauge tube is mounted is electrically grounded.

Use an appropriate power source of 12 to 30 Vdc, 2 W or use InstruTech series PS301 optional power supplies.

Turn off power to the unit before attempting to service the controller.

Turn off power to the unit if a cable or plug is damaged or the product is not operating normally according to this instruction manual. Contact qualified InstruTech service personnel for any service or troubleshooting condition that may not be covered by this instruction manual.

It is important that the product be periodically inspected for sound electrical connections and equipment grounding. Do not use if the equipment grounding or electrical insulation has been compromised.

Do not use if the unit has been dropped or the enclosure has been damaged. Contact InstruTech for return authorization and instructions for returning the product to InstruTech for evaluation.

2.3 Electrical Conditions

 **WARNING!** When high voltage is present in any vacuum system, a life threatening electrical shock hazard may exist unless all exposed electrical conductors are maintained at earth ground potential. This applies to all products that come in contact with the gas contained in vacuum chambers. An electrical discharge within a gaseous environment may couple dangerous high voltage directly to any ungrounded conductor of electricity. A person could be seriously injured or killed by coming in contact with an exposed, ungrounded electrical conductor at high voltage potential. This condition applies to all products that may come in contact with the gas inside the vacuum chamber (vacuum/pressure containment vessel).

2.3.1 Proper Equipment Grounding

 **WARNING!** Hazardous voltages that could seriously injure or cause death are present in many vacuum processes. Verify that the vacuum port on which the CVG101 vacuum gauge tube is mounted is electrically grounded. Consult a qualified Electrician if you are in doubt about your equipment grounding. Proper grounding of your equipment is essential for safety as well as intended operation of the equipment. The CVG101 vacuum gauge tube and enclosure of the VGC301 controller must be connected directly to a good quality earth ground. Use a ground lug on the CVG101 gauge vacuum connection / flange if necessary.

⚠ WARNING! In order to protect personnel from electric shock and bodily harm, shield all conductors which are subject to potential high voltage electrical discharges in or around the vacuum system.

2.3.2 Electrical Interface and Control

It is the user's responsibility to ensure that the electrical signals from this product and any connections made to external devices, for example, relays and solenoids, are used in a safe manner. Always double check the system set-up before using any signals to automate your process. Perform a hazardous operation analysis of your system design and ensure safeguards and personnel safety measures are taken to prevent injury and property damage.

2.4 Overpressure and use with hazardous gases

⚠ WARNING! Install suitable protective devices that will limit the level of pressure inside your vacuum chamber to less than what the vacuum chamber system components are capable of withstanding. InstruTech gauges should not be used at pressures exceeding 1000 Torr absolute pressure.

In cases where an equipment failure could cause a hazardous condition, always implement fail-safe system operation. For example, use a pressure relief device in an automatic backfill operation where a malfunction could result in high internal pressures if the pressure relief device was not installed on the chamber.

The CVG101 vacuum gauge tube connected to the VGC301A controller is not intended for use at pressures above 20 psia (1000 torr); DO NOT exceed 35 psig (< 2 ½ bars) pressure inside the sensor. If your chamber goes to higher pressures, you should install an isolation valve or pressure relief device to protect the gauge tube from overpressure conditions. With some fittings, actual safe overpressure conditions may be lower; for example, a quick-connect, O-ring compression fitting may forcibly release the gauge tube from the vacuum chamber fitting with only a few psi over local uncorrected barometric (atmospheric) pressure.

⚠ CAUTION! If the internal pressure of a vacuum gauge device is allowed to increase above local uncorrected barometric pressure (atmospheric pressure side), vacuum fittings may release and possible overpressure conditions may cause leaks that would allow the gas inside the gauge tube to release into the atmosphere of the surrounding environment. Toxic, pyrophoric and flammable gases are examples of hazardous gases that if allowed to leak out of the vacuum/pressure containment vessel into the atmospheric environment, could cause bodily injury and possible damage to equipment. Never expose the gauge tube internal volume to pressure above local atmospheric pressure when using hazardous gases.

2.5 Gases other than Nitrogen / air

⚠ WARNING! Do not attempt to use with gases other than nitrogen (N₂) or air without referring to correction factor data tables.

InstruTech gauges and modules are calibrated for direct readout of nitrogen or air. Do not attempt to use with other gases such as argon (Ar) or carbon dioxide (CO₂) unless accurate conversion data for N₂ to other gas is properly used. Refer to sections titled [“Using the gauge with different gases”](#), [“Display”](#) and [“Analog Output”](#) for a more complete discussion.

⚠ WARNING! Do not use the convection gauge connected to this device in an explosive atmosphere or in the presence of flammable gases, vapors or fumes. Do not use this device to measure the pressure of explosive or combustible gases or gas mixtures. The sensor wire in the gauge normally operates at 125 °C, but if malfunction should occur, the wire temperature could exceed the ignition temperature of certain combustible gases and gas mixture. This could cause an explosion which could result in serious injury or death.

3 Installation

3.1 Mechanical Installation

The VGC301 is designed for use on a bench top, or it may be mounted in an instrument control panel.

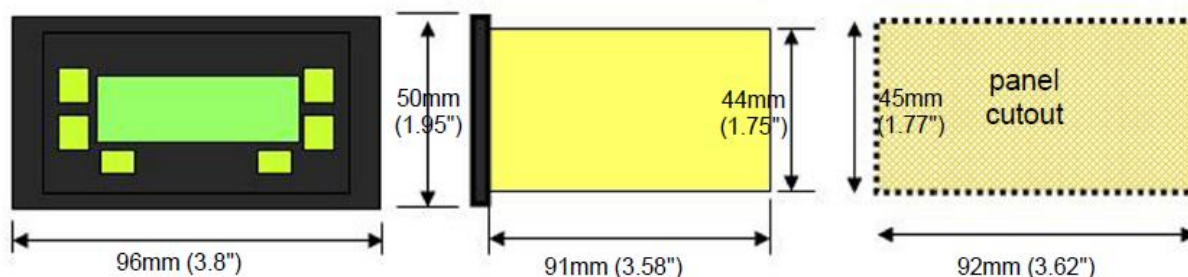

To mount the VGC301 in a panel:

1. Make a cutout in your instrument control panel as shown in the drawing above. Be sure to allow clearance behind the panel for the instrument as well as connectors and cables at the rear of the instrument

2. Gently pry the front panel bezel loose and remove.

3. Slide the VGC301 into the panel hole cutout.

4. On either side of the VGC301 are two screw-mounting brackets. When the screws in the front of the instrument are turned counterclockwise, the hold-down brackets recess out of the way into the VGC301 housing. When these screws are turned clockwise, the brackets rotate out 90° behind the panel. Tighten these screws until the brackets hold the VGC301 in place against the panel.

5. Press the front panel bezel back in place.

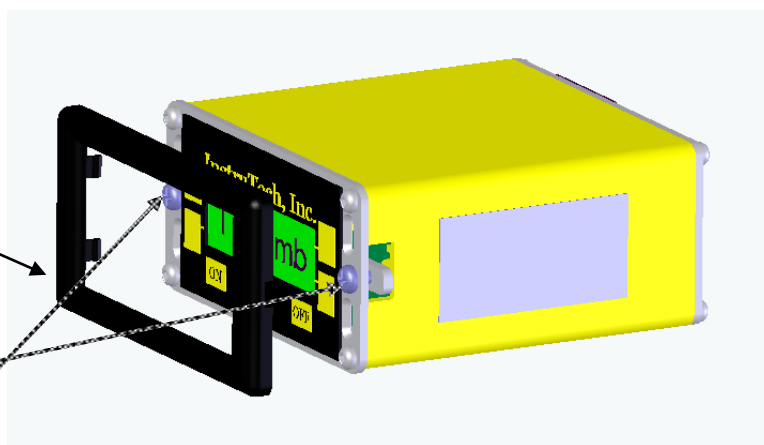

3.2 Electrical Installation

3.2.1 Grounding

⚠ Be sure the vacuum gauge and your vacuum system are properly grounded to protect personnel from shock and injury. Be aware that some vacuum fittings, especially those with O-rings, may not produce a good electrical connection between the gauge and the chamber it is connected to.

3.2.2 Electrical Connections

A good recommended practice is to remove power from any cable prior to connecting or disconnecting it.

The InstruTech VGC301 may replace similar controllers from other manufacturers, such as the Granville-Phillips® 375 controller. Many of these other controllers employ the same 9-pin and 15-pin D connectors, but they do not all use the same signal / pinout configurations. If you wish to use your existing cables, be sure to check compatibility with the tables on the next page. Rewire your cables as necessary.

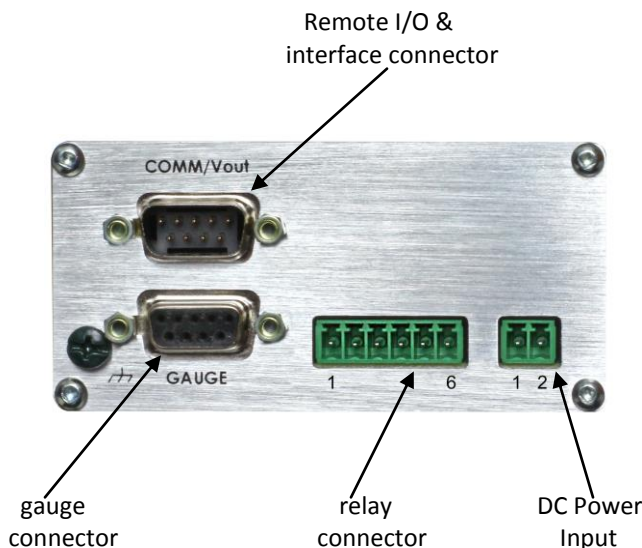

DC Power Input

The VGC301 accepts DC power from 12 to 30 Vdc, 2 W. If the user prefers to use AC power, InstruTech offers the series PS301 optional power supplies with various AC Plugs.

2-pin pluggable terminal strip (Mating connector: Phoenix p/n 1803578 or InstruTech p/n 000729).

pin number	pin description
1	+12 to +30 V
2	ground

Remote I/O & Interface Connector

9-pin D-sub female (Mating connector: InstruTech p/n 000263 + 000264)

pin number	pin description – 4 Wire RS485	pin description – 2 Wire RS485
1	RS485 RDA (-) Input	RS485 DATA A (-) Input/output
2	RS485 RDB (+) Input	RS485 DATA B (+) Input/output
3	RS485 TDA (-) Output	
4	RS485 TDB (+) Output	
5	RS232 TX	RS232 TX
6	RS232 RX	RS232 RX
7	analog output signal (non-linear, linear, or log-linear)	analog output signal (non-linear, linear, or log-linear)
8	analog output signal ground	analog output signal ground
9	relay disable ⁽¹⁾	relay disable ⁽¹⁾

1. The relays are disabled by applying a continuous ground to pin # 9. This will prevent any switching of the relay contactors during operation of the VGC301.

Relay Connector

6-pin pluggable terminal strip (Mating connector: Phoenix p/n1803617 or InstruTech p/n 000730)

pin number	pin description
1	relay 1 common
2	relay 1 NC
3	relay 1 NO
4	relay 2 common
5	relay 2 NC
6	relay 2 NO

Gauge cable assembly

P/N CB421-1-XXXF is a custom cable assembly provided in different lengths from InstruTech for connecting the VGC301 controller to InstruTech CVG101 *Worker Bee* or Brooks Automation, Inc. / Granville-Phillips® 275 Convectron® vacuum gauge sensor. The cable pin to pin connection is shown below.

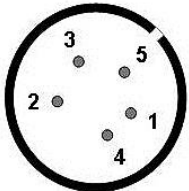
VGC301 pin number	connects to	CVG101 gauge pin number	CVG101 molded plastic connector P/N CK431-01
1		No Connection	
2		cable shield	
3		3	
4		3	
5		2	
6		5	
7		1	
8		1	
9		No Connection	

4 Setup and Operation

4.1 User Interface Basics

The user interface is designed for easy operation and a natural progression of setup parameters. This section gives a brief explanation of operation for added clarity.

There are four soft-keys located on the front panel, two on each side of the display. These keys are used to select and program the various functions available. During programming of the VGC301, the display will identify what function each key represents.

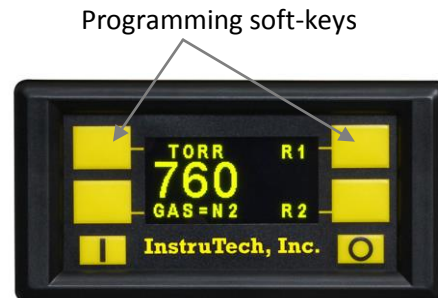

To begin programming, press any one of the four keys. The display will indicate a choice of functions. Press the key indicated by the function on the display to continue with the programming of the parameter desired. After setting the various parameters, press the SAVE/EXIT key to save the new setting and return to the main screen. To continue setting additional parameters, scroll forward with the MORE key until you reach the desired parameter.

4.2 Programming

SET VAC

NOTICE

When operating in units of either mbars (mbar) or pascals (Pa), you must perform SET ATM before setting the vacuum reading (SET VAC). See SET ATM below. Failure to do so will result in improper operation of the gauge. If you change units of measure or reset to factory defaults, then this same procedure must be followed again if the units of measure are being set to either mbar or Pa.

1. To properly set the vacuum reading (“zero” point), with the CVG101 installed on your vacuum system, the gauge should be evacuated to a pressure below 1×10^{-4} Torr.
2. Go to the **SET VAC** screen. When the vacuum system pressure is below 1×10^{-4} Torr, press the **PRESS TO SET VAC** key. The zero point (displayed pressure reading with gauge exposed to vacuum) is now set.

UNITS [Factory default = TORR]

This should be the first parameter that is set. This will be the units-of-measure (Torr, mbar, Pa) that are used for all other settings. If your VGC301 has been previously configured and relay setpoints and linear analog output pressure settings have been programmed, changing units-of-measure will return the relays setpoints and the linear analog output pressure settings to factory default setting values in Torr. In this case, you must reprogram the relay setpoints and linear analog output pressure settings in the newly programmed units-of-measure.

SET ATM

1. To set the atmospheric pressure reading (also known as the “span” adjustment), flow nitrogen gas or air into your closed vacuum chamber to allow the pressure to rise to a known value above 400 Torr. Alternatively, if your local uncorrected barometric pressure (air) is known, simply vent your vacuum system chamber to expose the gauge to the local atmospheric pressure.
2. Go to the **SET ATM** screen. When the desired pressure is stable, adjust the displayed pressure reading on the VGC301 to the known value using the **INCR** (increase) or **DECR** (decrease) keys. Press the **SAVE/EXIT** key to save the new atmospheric (span) pressure value.

It is good practice to perform the sequence of checking and adjusting span (ATM) then zero (VAC) and then, finally re-checking the span setting to ensure that the circuitry is properly balanced for use in measuring pressure throughout the intended measurement range.

SP1 ON and SP2 ON [Factory default = 100 mTORR]

These setpoints correspond to the pressures at which the relays will turn on (energize). The relays will turn on when the pressure is below the programmed pressure value. If you are unable to increase the values of SP1 ON or SP2 ON, you must first go to SP1 OFF or SP2 OFF and increase those values to a number higher than the values of SP1 ON or SP2 ON you are trying to set.

SET SP1 OFF and SET SP2 OFF [Factory default = 200 mTORR]

These setpoints correspond to the pressures at which the relays will turn off (de-energize). The relays will turn off when the pressure is above the programmed pressure value. If you are unable to decrease the values of SP1 OFF or SP2 OFF, you must first go to SP1 ON or SP2 ON and decrease those values to a number lower than the values of SP1 OFF or SP2 OFF you are trying to set.

RS485 ADDR [Factory default = 1]

This is the lower nibble of the one byte RS485 device address. Assuming the address offset (ADDR OFFSET) is equal to 0, setting the ADDR to a 5 will make the address be 0x05 in hexadecimal. A 15 will set the ADDR to 0x0F in hexadecimal. Note that the address (ADDR) must be used even when sending RS232 commands

RS485 OFFSET [Factory default = 0]

This is the upper nibble of the one byte RS485 address. Assuming the address (ADDR) is 0, setting the address offset (ADDR OFFSET) to a 5 will make the address be 0x50 hexadecimal. Setting the address offset to 15 will make the device address be 0xF0 hexadecimal.

ADDRESS DECIMAL	BINARY ADDRESS		ADDRESS HEXADECIMAL
	ONE BYTE (BINARY)		
	ADDR OFFSET ┌Upper nibble┐	ADDR ┌Lower nibble┐	
1	0 0 0 0	0 0 0 1	01
5	0 0 0 0	0 1 0 1	05
15	0 0 0 0	1 1 1 1	0F
16	0 0 0 1	0 0 0 0	F0

BAUD [Factory default = 19,200]

This sets the baud rate for the RS485 and the RS232 serial communications. The baud rate can be set to various values through the serial interface or via the front panel soft-keys. The parity can only be changed through the serial interface command set. When this occurs, the current setting will be shown in the list of choices and can be re-selected if changed.

RS485 Type [Factory default = 2 WIRE]

Selects 2-wire or 4-wire configuration for RS485 interface.

ANALOG TYPE [Factory default = LOG 1-8]

Select one of the following analog output types based on your system requirements (See [section 7.0](#) for more details to determine which analog output type to use).

- a) LOG 1-8. This selection provides a 1 to 8 Vdc log-linear analog output with 1 V/decade.
- b) LOG 0-7. This selection provides a 0 to 7 Vdc log-linear analog output with 1 V/decade.
- c) NONLIN 6V. This selection provides a non-linear (S-Curve) analog output from 0.3751 to 5.6593 Vdc.
- d) NONLIN 9V. This selection provides a non-linear (S-Curve) analog output from 0 to 9 Vdc.
- e) LINEAR. This selection provides a 0 to 10 Vdc linear analog output with a useful range over 3 decades.

SET LINEAR [Factory default = 0.01 VOLTS to 10 VOLTS corresponding to 1 mTORR to 1 TORR]

If you have selected LINEAR in the ANALOG TYPE menu above, then configure the linear analog output scaling using the following parameters in the **SET LINEAR** menu. (See [section 7.9](#) for more details).

- a) Set the minimum pressure
- b) Set the minimum voltage corresponding to the minimum pressure
- c) Set the maximum pressure
- d) Set the maximum voltage corresponding to the maximum pressure

The linear output voltage can be any value between 0.01 Vdc and 10 Vdc corresponding to pressures between 1 mTorr and 1000 Torr. However, the useful range of the linear analog output is three decades.

INFO

This screen shows the unit firmware version.

4.3 Return to Factory Default Settings

You can reset all values to the original factory default settings by simultaneously pressing the upper left and upper right soft-keys. The user will then be prompted to "Set Factory Defaults?" Choose Yes or No.

5 Using the gauge with different gases

A thermal conductivity gauge senses heat loss which depends on the thermal conductivity of the gas surrounding the sensor. Since different gases, and mixtures, have different thermal conductivities, the indicated pressure readings and outputs will also be different. InstruTech convection gauges (and most other thermal conductivity gauges) are calibrated using nitrogen (N_2). When a gas other than N_2 / air is used, correction must be made for the difference in thermal conductivity between nitrogen (N_2) and the gas in use. The charts and tables on the following pages indicate how different gases affect the display and output from an InstruTech convection gauge.

 **WARNING!** Using a thermal conductivity gauge with gases other than that for which it is calibrated could result in death or serious injury. Be sure to use gas correction data in this manual when measuring pressures of gases other than N_2 / air.

For N_2 the calibration shows excellent agreement between indicated and true pressure throughout the range from 10^{-4} to 1000 Torr. At pressures below 1 Torr, the calibration curves for the different gases are similar. The difference in readings at these low pressures is a constant, a function of the difference between thermal conductivities of the gases.

At pressures above 1 Torr, indicated pressure readings may diverge significantly. At these higher pressures convection currents in the gauge become the predominant cause of heat loss from the sensor and calibration depends on gauge tube geometry and mounting position as well as gas properties.

Generally, air and N_2 are considered the same with respect to thermal conductivity, but even N_2 and air will exhibit slight differences in readings at higher pressures. For example, when venting a system to atmosphere using N_2 , you may see readings change by 30 to 40 Torr after the chamber is opened and air gradually displaces the N_2 in the gauge. For most other gases the effect is much more significant and may result in a hazardous condition as described below.

Other considerations when using gases other than N_2 / air

Flammable or explosive gases

 **WARNING!** InstruTech convection gauges are neither intrinsically safe nor explosion proof and are not intended for use in the presence of flammable or explosive gases or vapors.

Under normal conditions the voltages and currents in InstruTech convection gauges are too low to cause ignition of flammable gases. However, under certain failure conditions, sufficient energy could be generated to cause flammable vapors or gases to ignite or explode. Thermal conductivity gauges like the InstruTech convection gauges are not recommended for use with flammable or explosive gases.

Moisture / water vapor

In some processes (lyophilization, for example) the gas composition may not change significantly, except for moisture content. Water vapor can significantly change the response of a thermal gauge and correction should be made, as you would for any other gas.

Other contaminants

If your gases condense, coat, or corrode the sensor, the gauge calibration and response to different gases will change. Generally, if the gauge can be "calibrated" ("zero" and "span" settings), these changes are small enough to be ignored. If you can't set zero and span, the gauge should be replaced or return to factory for evaluation and possible cleaning.

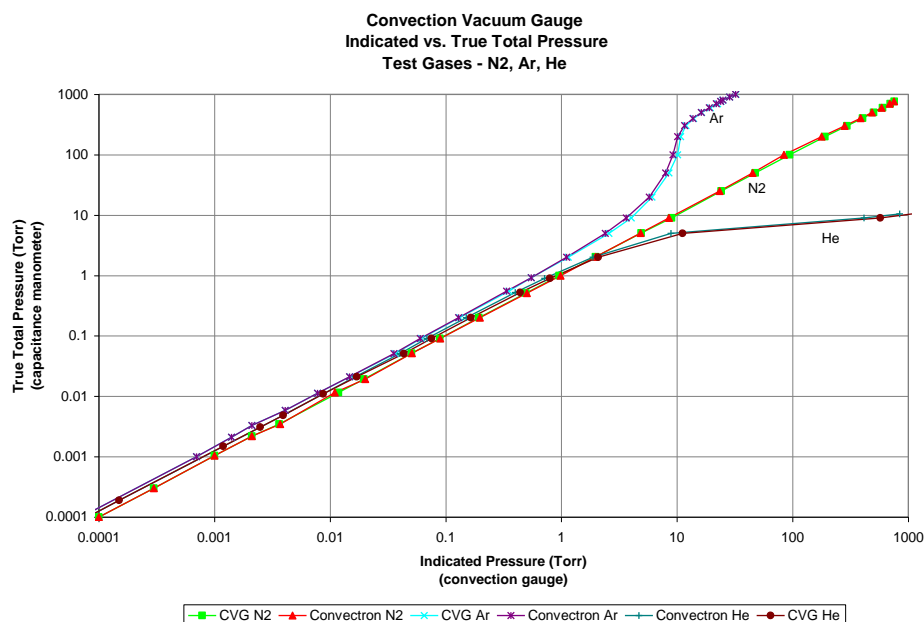

Gas Correction Chart

The Y-axis of the above chart is actual pressure as measured by a capacitance manometer, a diaphragm gauge that measures true total pressure independent of gas composition. The X-axis is the pressure reading indicated by the convection gauge under test. This chart shows readings for an InstruTech convection gauge (CVG) and Granville-Phillips® Convector® gauge to illustrate that the difference in the response for both of these types of gauges is virtually indistinguishable.

CAUTION! Do not assume this data applies to other convection gauges which may or may not be the same. Refer to the table on the next page and note the following examples:

Ex A: If the gas is nitrogen (N₂), when the true total pressure is 500 Torr, the gauge will read 500 Torr.

Ex B: If the gas is argon (Ar), when the true pressure is 100 Torr, the gauge will read about 9 Torr.

If you are backfilling your vacuum system with Ar, when your system reaches a pressure of 760 Torr true pressure your gauge will be reading about 23 Torr. Continuing to backfill your system, attempting to increase the reading up to 760 Torr, you will over pressurize your chamber which may present a hazard.

Ex C: If the gas is helium (He), the gauge will read 999 Torr when pressure reaches about 10 Torr true pressure and opening the chamber to atmosphere prematurely may present other hazards for both people and product.

CAUTION! What these examples illustrate is that using gases other than nitrogen (N₂) without using accurate gas conversion data and other proper precautions could result in injury to personnel and/or damage to equipment.

Suggested precautions when using gases other than nitrogen (N₂):

Install a pressure relief valve or burst disk on your chamber, to protect it from overpressure. Post a warning label on your gauge readout that states "Do Not Exceed ____ Torr Indicated Pressure" (fill in the blank for maximum indicated pressure for the gas you use) so that an operator using the gauge will not exceed a safe pressure.

6 Display

6.1 Display - Torr / mTorr

The table below shows the displayed readings at various pressures for selected gases when engineering units selected is in Torr/mTorr.

Displayed Pressure Readings vs. True Pressure for selected gases

Pressures shown in bold italic font in the shaded areas are in mTorr.

Pressures shown in normal font and in non-shaded areas are in Torr.

True Total Pressure	N ₂	Ar	He	O ₂	CO ₂	Kr	Freon12	Freon22	D ₂	Ne	CH ₄
0 mTorr	0.0	0.0	0.0	0.0	0.0	0.0	0.0	0.0	0.0	0.0	0.0
0.1 mTorr	0.1	0.1	0.1	0.1	0.1	0.1	0.1	0.1	0.1	0.1	0.1
0.2 mTorr	0.2	0.2	0.2	0.2	0.2	0.2	0.2	0.2	0.2	0.2	0.2
0.5 mTorr	0.5	0.5	0.5	0.5	0.5	0.3	0.5	0.5	0.5	0.5	0.5
1 mTorr	1.0	0.7	0.8	1.0	1.1	0.4	1.5	1.5	1.3	0.7	1.7
2 mTorr	2.0	1.4	1.6	2.0	2.3	1.0	3.1	3.1	2.4	1.5	3.3
5 mTorr	5.0	3.3	4.0	5.0	4.4	2.3	7.6	7.0	6.0	3.5	7.7
10 mTorr	10.0	6.6	8.1	9.7	11.0	4.8	14.7	13.5	12.1	7.1	15.3
20 mTorr	20.0	13.1	16.1	19.8	22.2	9.5	29.9	27.2	24.3	14.1	30.4
50 mTorr	50.0	32.4	40.5	49.2	54.9	23.5	72.5	69.0	60.0	34.8	77.2
100 mTorr	100	64.3	82.0	97.2	107	46.8	143	136	121	70.0	159
200 mTorr	200	126	165	194	210	91.1	275	262	250	141	315
500 mTorr	500	312	435	486	489	217	611	594	687	359	781
1 Torr	1.00	600	940	970	950	400	1.05	1.04	1.55	745	1.60
2 Torr	2.00	1.14	2.22	1.94	1.71	700	1.62	1.66	4.13	1.59	3.33
5 Torr	5.00	2.45	13.5	4.98	3.34	1.28	2.45	2.62	246	5.24	7.53
10 Torr	10.0	4.00	OP	10.3	4.97	1.78	2.96	3.39	OP	21.5	27.9
20 Torr	20.0	5.80	OP	22.3	6.59	2.29	3.32	3.72	OP	584	355
50 Torr	50.0	7.85	OP	77.6	8.22	2.57	3.79	4.14	OP	OP	842
100 Torr	100	8.83	OP	209	9.25	2.74	4.68	4.91	OP	OP	OP
200 Torr	200	9.79	OP	295	12.3	3.32	5.99	6.42	OP	OP	OP
300 Torr	300	11.3	OP	380	16.9	3.59	6.89	7.52	OP	OP	OP
400 Torr	400	13.5	OP	485	22.4	3.94	7.63	8.42	OP	OP	OP
500 Torr	500	16.1	OP	604	28.7	4.21	8.28	9.21	OP	OP	OP
600 Torr	600	18.8	OP	730	36.4	4.44	8.86	9.95	OP	OP	OP
700 Torr	700	21.8	OP	859	46.1	4.65	9.42	10.7	OP	OP	OP
760 Torr	760	23.7	OP	941	53.9	4.75	9.76	11.1	OP	OP	OP
800 Torr	800	25.1	OP	997	59.4	4.84	9.95	11.4	OP	OP	OP
900 Torr	900	28.5	OP	OP	79.5	4.99	10.5	12.0	OP	OP	OP
1000 Torr	1000	32.5	OP	OP	111	5.08	11.1	12.7	OP	OP	OP

Notes:

- 1) OP = overpressure indication: display will read over pressure
- 2) Display auto-ranges between Torr and mTorr at 1 Torr

Examples

- 1) Gas used is nitrogen (N₂). Display shows pressure measurement of 10 Torr. True pressure of nitrogen is 10 Torr.
- 2) Gas used is argon (Ar). Display shows pressure measurement of 600 mTorr. True pressure of argon is 1 Torr.
- 3) Gas used is oxygen (O₂). Display shows pressure measurement of 486 mTorr. True pressure of oxygen is 500 mTorr.

6.2 Display - mbar

The table below shows the displayed readings at various pressures for selected gases when engineering units selected is in mbar.

Displayed Pressure Readings vs. True Pressure for selected gases - Engineering units in mbar

True Pressure	N ₂	Ar	He	O ₂	CO ₂	KR	Freon12	Freon22	D ₂	Ne	CH ₄
0 mbar	0.0	0.0	0.0	0.0	0.0	0.0	0.0	0.0	0.0	0.0	0.0
.0001 mbar	.0001	.0001	.0001	.0001	.0001	.0001	.0001	.0001	.0001	.0001	.0001
.0003 mbar	.0003	.0003	.0003	.0003	.0003	.0003	.0003	.0003	.0003	.0003	.0003
.0006 mbar	.0006	.0006	.0006	.0006	.0006	.0004	.0006	.0006	.0006	.0006	.0006
.0013 mbar	.0013	.0009	.0011	.0013	.0015	.0005	.0020	.0020	.0017	.0009	.0023
.0027 mbar	.0027	.0019	.0021	.0027	.0031	.0013	.0041	.0041	.0032	.0020	.0044
.0067 mbar	.0067	.0044	.0053	.0067	.0059	.0031	.0101	.0093	.0080	.0047	.0102
.0133 mbar	.0133	.0088	.0107	.0129	.0146	.0064	.0195	.0179	.0161	.0095	.0203
.0260 mbar	.0260	.0174	.0214	.0263	.0295	.0126	.0398	.0362	.0323	.0187	.0405
.0666 mbar	.0666	.0431	.0539	.0655	.0731	.0313	.0966	.0919	.0799	.0463	0.100
0.130 mbar	0.130	.0857	0.110	0.120	0.140	.0623	0.190	0.180	0.160	0.100	0.210
0.260 mbar	0.260	0.160	0.210	0.250	0.270	0.120	0.360	0.340	0.330	0.180	0.410
0.666 mbar	0.666	0.410	0.570	0.640	0.650	0.280	0.810	0.790	0.91	0.470	1.04
1.33 mbar	1.33	0.790	1.25	1.29	1.26	0.530	1.39	1.38	2.06	0.990	2.13
2.66 mbar	2.66	1.51	2.95	2.58	2.27	0.930	2.15	2.21	5.50	2.11	4.43
6.66 mbar	6.66	3.26	17.9	6.63	4.45	1.70	3.26	3.49	327	6.98	10.0
13.3 mbar	13.3	5.33	OP	13.7	6.62	2.37	3.94	4.51	OP	28.6	37.1
26.6 mbar	26.6	7.73	OP	29.7	8.78	3.05	4.42	4.95	OP	778	473
66.6 mbar	66.6	10.4	OP	103	10.9	3.42	5.05	5.51	OP	OP	1012
133 mbar	133	11.7	OP	278	12.3	3.65	6.23	6.54	OP	OP	OP
266 mbar	266	13.0	OP	393	16.3	4.42	7.98	8.55	OP	OP	OP
400 mbar	400	15.0	OP	506	22.5	4.78	9.18	10.0	OP	OP	OP
533 mbar	533	17.9	OP	646	29.8	5.25	10.1	11.2	OP	OP	OP
666 mbar	666	21.4	OP	805	38.2	5.61	11.0	12.2	OP	OP	OP
800 mbar	800	25.0	OP	973	48.5	5.91	11.8	13.2	OP	OP	OP
933 mbar	933	29.0	OP	1140	61.4	6.19	12.5	14.2	OP	OP	OP
1011 mbar	1011	31.5	OP	1250	71.8	6.33	13.0	14.7	OP	OP	OP
1060 mbar	1060	33.4	OP	1320	79.1	6.45	13.2	15.1	OP	OP	OP
1190 mbar	1019	37.9	OP	OP	105	6.65	13.9	16.0	OP	OP	OP
1330 mbar	1330	43.3	OP	OP	147	6.77	14.7	16.9	OP	OP	OP

Values listed under each gas type are in mbar.

Notes:

- 1) OP = Overpressure indication; display will read "overpressure".

Examples:

- 1) Gas used is nitrogen. Display shows pressure measurement of 13.3 mbar. True pressure of nitrogen is 13.3 mbar.
- 2) Gas used is argon. Display shows pressure measurement of 11.7 mbar. True pressure of argon is 133 mbar.
- 3) Gas used is CO₂. Display shows pressure measurement of .0731 mbar. True pressure of CO₂ is .0666 mbar.

7 Analog Output

The VGC301 provides either a non-linear, log-linear or a 0-10 Vdc linear analog output signal. These analog output signals are also compatible with various Granville-Phillips® Mini-Convectron® modules as well as Convectron® gauge controller series 375, 475 and the original 1/4 DN 275 Analog Convectron Gauge Controllers. Please read this section in its entirety to determine which one of the five analog output types to select from.

The analog output information described in this User Manuals applies to VGC301 manufactured with the current firmware **XXXXX-11** and higher (last two digits of **11** or higher). See *INFO* screen of the VGC301 display menu to determine the firmware version you are using. When compared to the previous versions of the VGC301 firmware, the current version of the firmware provides additional analog output scaling options as listed in the table below.

Analog Output Types	Current VGC301 Firmware XXXXX- 11 (last 2 digits = 11 or Higher) ANALOG TYPE Menu Selection	Previous VGC301 firmware XXXXX- 10 (last 2 digits = 10 or lower) ANALOG TYPE Menu Selection
Log-Linear 1 to 8 Vdc, 1 V/decade	LOG 1-8	= LOG
Log-Linear 0 to 7 Vdc, 1 V/decade	LOG 0-7	= Not Available
Non-Linear 0.375 to 5.659 Vdc, S-Curve	NONLIN 6V	= NONLIN
Non-Linear 0 to 9 Vdc, S-Curve	NONLIN 9V	= Not Available
Linear 0 to 10 Vdc	LINEAR	= LINEAR

LOG 1-8; Log-Linear Analog Output

The LOG 1-8 setting selected from the ANALOG TYPE menu produces a log-linear analog output signal of **1 to 8 Vdc for 1.0E-4 to 1000 Torr of N₂**. This output, shown at right, is a 1 Volt per decade signal that may be easier to use for data logging/control than the non-linear analog output.

Selecting the LOG 1-8 setting from the InstruTech VGC301 ANALOG TYPE menu duplicates the analog outputs of the Granville-Phillips Convectron® gauge controller series 375 and 475.

If you also have a previous version(s) of the VGC301 product manufactured with firmware XXXXX-10 or lower (last 2 digits of 10 or lower, see firmware number in the INFO screen of the display menu), the “LOG 1-8 ” menu selection in the current firmware corresponds to the “LOG” menu selection of the older firmware

The equations and tables shown in [section 7.1](#) and [section 7.2](#) contain the lookup data for converting the **LOG 1-8** output voltage into pressure values for nitrogen and various other gases.

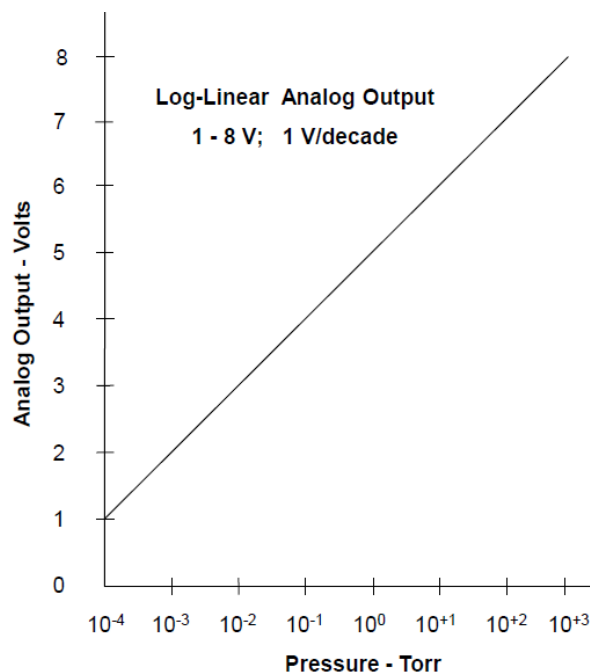

LOG 0-7; Log-Linear Analog Output

The LOG 0-7 setting selected from the ANALOG TYPE menu produces a log-linear analog output signal of **0 to 7 Vdc for 1.0E-4 to 1000 Torr of N₂**. This output, shown at right, is a 1 Volt per decade signal that may be easier to use for data logging/control than the non-linear output.

Selecting the LOG 0-7 setting from the InstruTech VGC301 ANALOG TYPE menu duplicates the analog outputs of the Granville-Phillips Convectron® gauge controller series 375 and 475.

The LOG 0-7 option was not previously available for the VGC301 product manufactured with firmware XXXXX-10 or lower (last 2 digits of 10 or lower, see firmware number in the INFO screen of the display menu).

The equations and tables shown in [section 7.3](#) and [section 7.4](#) contain the lookup data for converting the **LOG 0-7** output voltage into pressure values for nitrogen and various other gases.

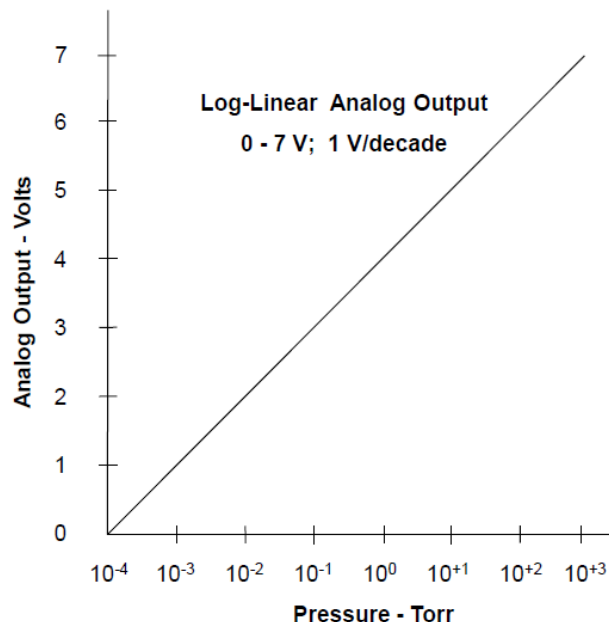

NONLIN 6V; Non-Linear Analog Output, S-Curve

The NONLIN 6V setting selected from the ANALOG TYPE menu produces a non-linear analog output signal of **0.375 to 5.659 Vdc for 0 to 1000 Torr of N₂**, roughly in the shape of an "S" curve, as shown at right.

Selecting the NONLIN 6V setting from the InstruTech VGC301 ANALOG TYPE menu duplicates the Granville-Phillips Mini-Convectron® modules original S-curve of 0.375 to 5.659 Vdc corresponding to 0 to 1000 Torr.

If you also have a previous version(s) of the VGC301 product manufactured with firmware XXXXX-10 or lower (last 2 digits of 10 or lower, see firmware number in the INFO screen of the display menu), the "NONLIN 6V" menu selection in the current firmware corresponds to the "NONLIN" menu selection of the older firmware.

The equations shown in [section 7.5](#) and tables shown in [section 7.6](#) and [section 7.7](#) contain the lookup data for converting the **NONLIN 6V** output voltage into pressure values for nitrogen and various other gases.

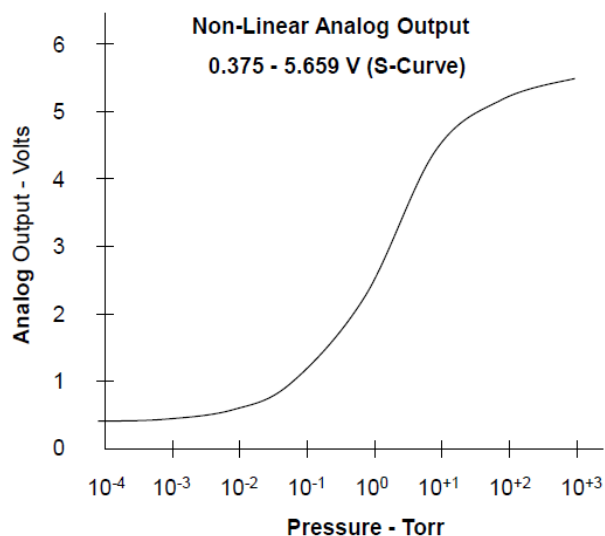

NONLIN 9V; Non-Linear Analog Output, S-Curve

The NONLIN 9V setting selected from the ANALOG TYPE menu produces a non-linear analog output signal of **0 to 9 Vdc for 0 to 1000 Torr of N₂**, roughly in the shape of an "S" curve, as shown at right.

Selecting the NONLIN 9V setting from the InstruTech VGC301 ANALOG TYPE menu duplicates the analog outputs (S-Curve) of the Granville-Phillips Convector® gauge controller series 375, 475 and the original 1/4 DN 275 Analog Convector Gauge Controllers.

The NONLIN 9V option was not previously available for the VGC301 product manufactured with firmware XXXXX-10 or lower (last 2 digits of 10 or lower, see firmware number in the INFO screen of the display menu).

The equations and table shown in [section 7.8](#) contain the lookup data for converting the **NONLIN 9V** output voltage into pressure values for nitrogen and various other gases.

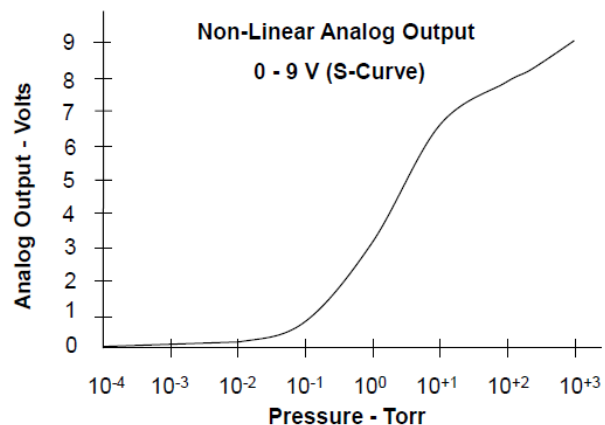

LINEAR; 0-10 Vdc Linear Analog Output

The VGC301 also provides a linear 0-10 Vdc analog output. The linear output voltage can be any value between 0.01 V and 10 V corresponding to displayed pressure between 1 mTorr and 1000 Torr. However, the useful range of the linear analog output is three decades. For example if the minimum pressure selected is 1 mTorr (1.0×10^{-3} Torr) with a corresponding minimum voltage output of 0.01 volts, then maximum pressure selected to correspond to a maximum voltage output of 10 volts should not exceed 1.00 Torr. If your application requires the analog output to cover a pressure range exceeding three decades then consider using the log-linear or non-linear analog output. See [section 7.9](#) for more detailed explanation.

7.1 Log 1-8; Log-Linear Analog Output Equation & Table - Torr

Log-Linear 1 to 8 V analog output for selected gases - Engineering units in Torr

True Pressure (Torr)	N ₂	Ar	He	O ₂	CO ₂	Kr	Freon12	Freon22	D ₂	Ne	CH ₄
0.0001	1.000	1.000	1.000	1.000	1.000	1.000	1.000	1.000	1.000	1.000	1.000
0.0002	1.301	1.301	1.301	1.301	1.301	1.301	1.301	1.301	1.301	1.301	1.301
0.0005	1.699	1.699	1.699	1.699	1.699	1.477	1.699	1.699	1.699	1.699	1.699
0.0010	2.000	1.845	1.903	2.000	2.041	1.602	2.176	2.176	2.114	1.845	2.230
0.0020	2.301	2.146	2.204	2.301	2.362	2.000	2.491	2.491	2.380	2.176	2.519
0.0050	2.699	2.519	2.602	2.699	2.643	2.362	2.881	2.845	2.778	2.544	2.886
0.0100	3.000	2.820	2.908	2.987	3.041	2.681	3.167	3.130	3.083	2.851	3.185
0.0200	3.301	3.117	3.207	3.297	3.346	2.978	3.476	3.435	3.386	3.149	3.483
0.0500	3.699	3.511	3.607	3.692	3.740	3.371	3.860	3.839	3.778	3.542	3.888
0.1000	4.000	3.808	3.914	3.988	4.029	3.670	4.155	4.134	4.083	3.845	4.201
0.2000	4.301	4.100	4.217	4.288	4.322	3.960	4.439	4.418	4.398	4.149	4.498
0.5000	4.699	4.494	4.638	4.687	4.689	4.336	4.786	4.774	4.837	4.555	4.893
1.0000	5.000	4.778	4.973	4.987	4.978	4.602	5.021	5.017	5.190	4.872	5.204
2.0000	5.301	5.057	5.346	5.288	5.233	4.845	5.210	5.220	5.616	5.201	5.522
5.0000	5.699	5.389	6.130	5.697	5.524	5.107	5.389	5.418	7.391	5.719	5.877
10.0000	6.000	5.602	8.041	6.013	5.696	5.250	5.471	5.530	8.041	6.332	6.446
20.0000	6.301	5.763	8.041	6.348	5.819	5.360	5.521	5.571	8.041	7.766	7.550
50.0000	6.699	5.895	8.041	6.890	5.915	5.410	5.579	5.617	8.041	8.041	7.925
100.0000	7.000	5.946	8.041	7.320	5.966	5.438	5.670	5.691	8.041	8.041	8.041
200.0000	7.301	5.991	8.041	7.470	6.090	5.521	5.777	5.808	8.041	8.041	8.041
300.0000	7.477	6.053	8.041	7.580	6.228	5.555	5.838	5.876	8.041	8.041	8.041
400.0000	7.602	6.130	8.041	7.686	6.350	5.595	5.883	5.925	8.041	8.041	8.041
500.0000	7.699	6.207	8.041	7.781	6.458	5.624	5.918	5.964	8.041	8.041	8.041
600.0000	7.778	6.274	8.041	7.863	6.561	5.647	5.947	5.998	8.041	8.041	8.041
700.0000	7.845	6.338	8.041	7.934	6.664	5.667	5.974	6.029	8.041	8.041	8.041
760.0000	7.881	6.375	8.041	7.974	6.732	5.677	5.989	6.045	8.041	8.041	8.041
800.0000	7.903	6.400	8.041	7.999	6.774	5.685	5.998	6.057	8.041	8.041	8.041
900.0000	7.954	6.455	8.041	8.041	6.900	5.698	6.021	6.079	8.041	8.041	8.041
1000.0000	8.000	6.512	8.041	8.041	7.045	5.706	6.045	6.104	8.041	8.041	8.041

Values listed under each gas type are in volts.

The log-linear output signal and pressure are related by the following formulas:

$$P = 10^{(V-5)} \quad V = \log_{10}(P) + 5$$

where P is the pressure in torr, and V is the output signal in volts.

An analog output of 10 volts indicates a faulty convection gauge or unplugged gauge cable.

The chart on the following page shows the graphical results of the table and formulas given above for nitrogen. True pressure (N₂) is plotted on the X-axis with a log scale. The output signal is plotted on the Y-axis on a linear scale.

Note - when using the units of pascals and LOG 1-8 is selected, the same equation of $P = 10^{(V-5)}$ listed above applies. This results in a log-linear analog output range of 1 to 10.12 Vdc for 1.30E-02 pascals to 133 kpa.

LOG 1-8; Log-Linear Analog Output Voltage vs Pressure (Torr)

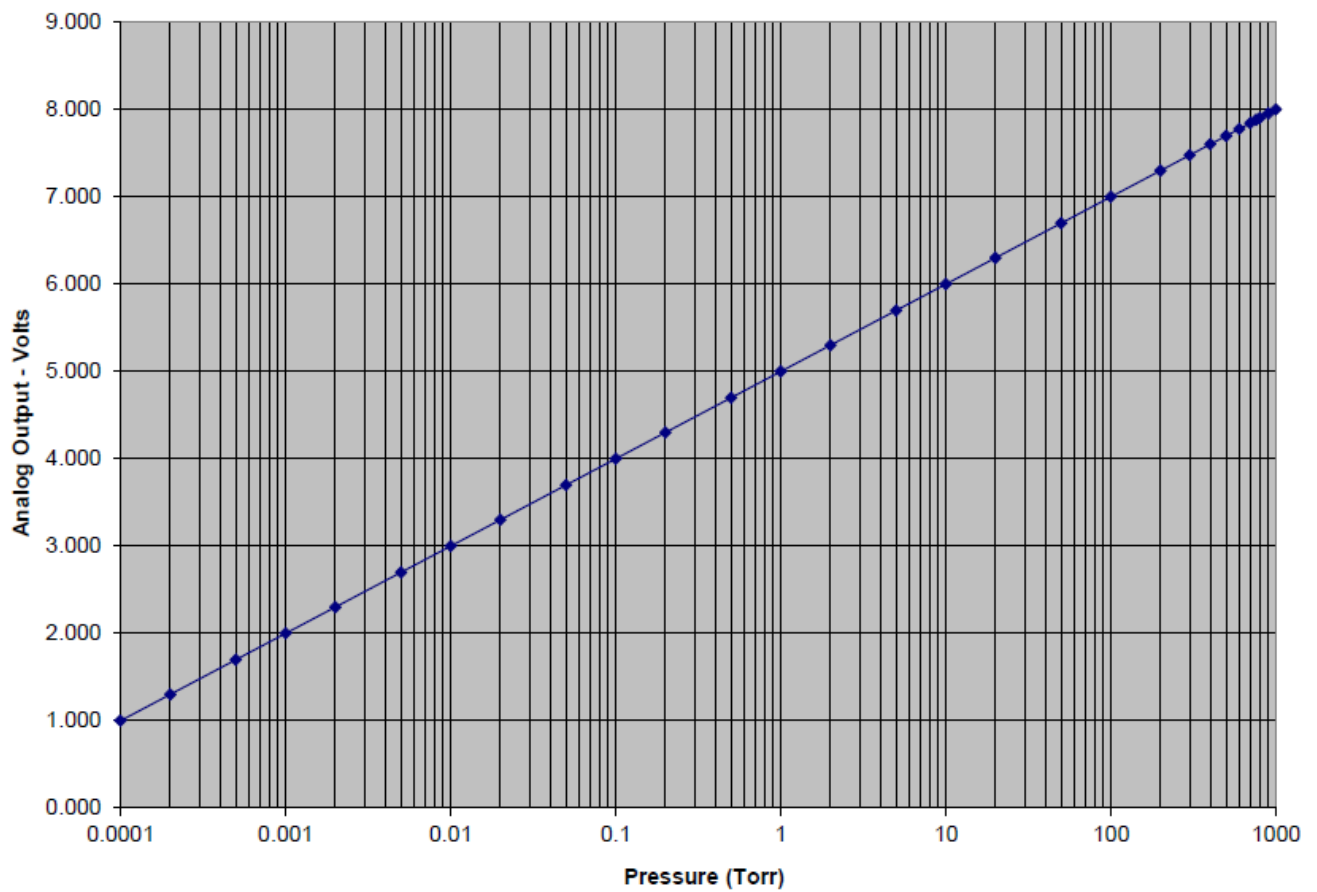

Chart of the calculated pressures using the formulas and data for the log-linear output signal for nitrogen from the previous page.

7.2 Log 1-8; Log-Linear Analog Output Equation & Table - mbar

Log-Linear 1 to 8 V analog output for selected gases - Engineering units in mbar

True Pressure (mbar)	N ₂	Ar	He	O ₂	CO ₂	KR	Freon12	Freon22	D ₂	Ne	CH ₄
0.0001	1.000	1.000	1.000	1.000	1.000	1.000	1.000	1.000	1.000	1.000	1.000
0.0002	1.301	1.301	1.301	1.301	1.301	1.301	1.301	1.301	1.301	1.301	1.301
0.0005	1.699	1.699	1.699	1.699	1.699	1.523	1.699	1.699	1.699	1.699	1.699
0.0010	2.000	1.903	1.938	2.000	2.028	1.668	2.125	2.125	2.080	1.903	2.167
0.0020	2.301	2.146	2.204	2.301	2.355	1.970	2.487	2.487	2.392	2.166	2.523
0.0050	2.699	2.524	2.602	2.699	2.672	2.370	2.883	2.855	2.778	2.551	2.893
0.0100	3.000	2.820	2.908	2.991	3.012	2.675	3.172	3.136	3.082	2.849	3.186
0.0200	3.301	3.188	3.208	3.294	3.345	2.979	3.473	3.434	3.385	3.150	3.484
0.0500	3.699	3.512	3.607	3.693	3.741	3.372	3.863	3.837	3.779	3.543	3.886
0.1000	4.000	3.809	3.928	3.989	4.033	3.671	4.157	4.136	4.082	3.844	4.197
0.2000	4.301	4.103	4.217	4.288	4.325	3.963	4.445	4.424	4.393	4.148	4.500
0.5000	4.699	4.495	4.634	4.686	4.696	4.341	4.798	4.783	4.828	4.553	4.893
1.0000	5.000	4.784	4.962	4.987	4.982	4.614	5.044	5.037	5.174	4.867	5.201
2.0000	5.301	5.064	5.324	5.288	5.249	4.865	5.250	5.255	5.579	5.192	5.517
5.0000	5.699	5.404	6.070	5.695	5.550	5.141	5.447	5.471	7.288	5.696	5.877
10.0000	6.000	5.633	8.125	6.008	5.743	5.309	5.556	5.602	8.125	6.252	6.374
20.0000	6.301	5.815	8.125	6.337	5.886	5.433	5.621	5.675	8.125	7.608	7.409
50.0000	6.699	5.969	8.125	6.862	6.002	5.514	5.680	5.722	8.125	8.125	7.930
100.0000	7.000	6.045	8.125	7.282	6.065	5.548	5.751	5.780	8.125	8.125	8.125
200.0000	7.301	6.093	8.125	7.526	6.157	5.606	5.851	5.877	8.125	8.125	8.125
300.0000	7.477	6.131	8.125	7.625	6.253	5.654	5.918	5.950	8.125	8.125	8.125
400.0000	7.602	6.178	8.125	7.705	6.353	5.679	5.962	6.000	8.125	8.125	8.125
500.0000	7.699	6.237	8.125	7.786	6.448	5.710	5.996	6.038	8.125	8.125	8.125
600.0000	7.778	6.295	8.125	7.861	6.532	5.734	6.025	6.070	8.125	8.125	8.125
700.0000	7.845	6.349	8.125	7.928	6.611	5.754	6.050	6.097	8.125	8.125	8.125
760.0000	7.881	6.380	8.125	7.965	6.658	5.765	6.063	6.112	8.125	8.125	8.125
800.0000	7.903	6.399	8.125	7.988	6.687	5.772	6.072	6.122	8.125	8.125	8.125
900.0000	7.954	6.488	8.125	8.042	6.766	5.787	6.092	6.146	8.125	8.125	8.125
1000.0000	8.000	6.494	8.125	8.092	6.847	5.799	6.111	6.167	8.125	8.125	8.125
1100.0000	8.041	6.539	8.125	8.125	6.936	5.812	6.128	6.187	8.125	8.125	8.125
1200.0000	8.079	6.580	8.125	8.125	7.028	5.822	6.146	6.204	8.125	8.125	8.125
1300.0000	8.114	6.624	8.125	8.125	7.140	5.828	6.164	6.222	8.125	8.125	8.125
1333.0000	8.125	6.636	8.125	8.125	7.169	5.830	6.169	6.228	8.125	8.125	8.125

Values listed under each gas type are in volts.

The log-linear output signal and pressure are related by the following formulas:

$$P = 10^{(V - 5)} \quad V = \log_{10}(P) + 5$$

where P is the pressure in mbar, and V is the output signal in volts.

An analog output of 10 volts indicates a faulty convection gauge or unplugged gauge cable.

The chart on the following page shows the graphical results of the table and formulas given above for nitrogen.

True pressure (N₂) is plotted on the X-axis with a log scale. The output signal is plotted on the Y-axis on a linear scale.

Note - when using the units of pascals and LOG 1-8 is selected, the same equation of $P = 10^{(V - 5)}$ listed above applies. This results in a log-linear analog output range of 1 to 10.12 Vdc for 1.30E-02 pascals to 133 kpa.

LOG 1-8; Log-Linear Analog Output Voltage vs Pressure (mbar)

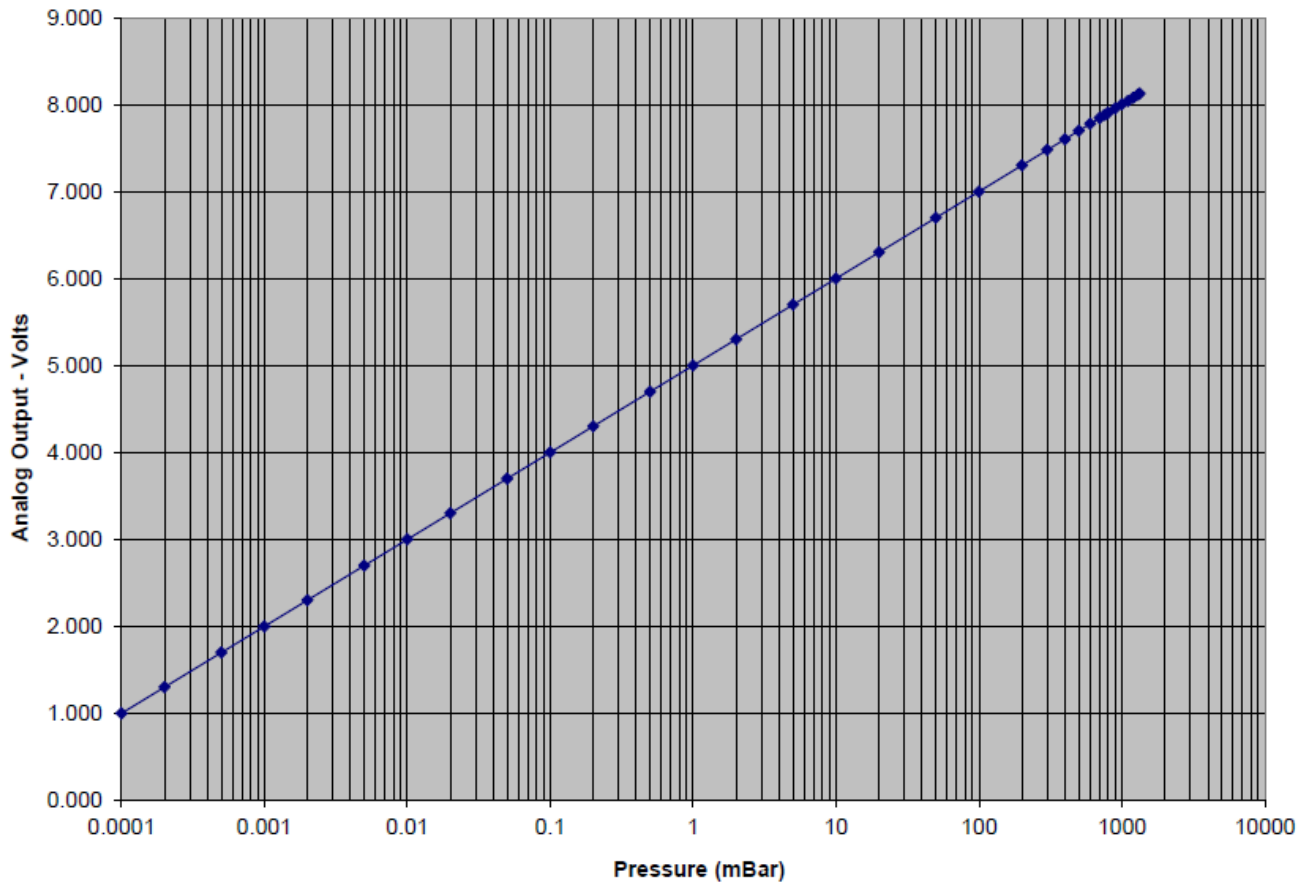

Chart of the calculated pressures using the formulas and data for the log-linear output signal for nitrogen from the previous page.

7.3 Log 0-7; Log-Linear Analog Output Equation & Table - Torr

Log-Linear 0 to 7 V analog output for selected gases - Engineering units in Torr

True Pressure (Torr)	N ₂	Ar	He	O ₂	CO ₂	KR	Freon12	Freon22	D ₂	Ne	CH ₄
0.0001	0.000	0.000	0.000	0.000	0.000	0.000	0.000	0.000	0.000	0.000	0.000
0.0002	0.301	0.301	0.301	0.301	0.301	0.301	0.301	0.301	0.301	0.301	0.301
0.0005	0.699	0.699	0.699	0.699	0.699	0.477	0.699	0.699	0.699	0.699	0.699
0.0010	1.000	0.845	0.903	1.000	1.041	0.602	1.176	1.176	1.114	0.845	1.230
0.0020	1.301	1.146	1.204	1.301	1.362	1.000	1.491	1.491	1.380	1.176	1.519
0.0050	1.699	1.519	1.602	1.699	1.643	1.362	1.881	1.845	1.778	1.544	1.886
0.0100	2.000	1.820	1.908	1.987	2.041	1.681	2.167	2.130	2.083	1.851	2.185
0.0200	2.301	2.117	2.207	2.297	2.346	1.978	2.476	2.435	2.386	2.149	2.483
0.0500	2.699	2.511	2.607	2.692	2.740	2.371	2.860	2.839	2.778	2.542	2.888
0.1000	3.000	2.808	2.914	2.988	3.029	2.670	3.155	3.134	3.083	2.845	3.201
0.2000	3.301	3.100	3.217	3.288	3.322	2.960	3.439	3.418	3.398	3.149	3.498
0.5000	3.699	3.494	3.638	3.687	3.689	3.336	3.786	3.774	3.837	3.555	3.893
1.0000	4.000	3.778	3.973	3.987	3.978	3.602	4.021	4.017	4.190	3.872	4.204
2.0000	4.301	4.057	4.346	4.288	4.233	3.845	4.210	4.220	4.616	4.201	4.522
5.0000	4.699	4.389	6.130	4.697	4.524	4.107	4.389	4.418	6.391	4.719	4.877
10.0000	5.000	4.602	7.041	5.013	4.696	4.250	4.471	4.530	7.041	5.332	5.446
20.0000	5.301	4.763	7.041	5.348	4.819	4.360	4.521	4.571	7.041	6.766	6.550
50.0000	5.699	4.895	7.041	5.890	4.915	4.410	4.579	4.617	7.041	7.041	6.925
100.0000	6.000	4.946	7.041	6.320	4.966	4.438	4.670	4.691	7.041	7.041	7.041
200.0000	6.301	4.991	7.041	6.470	5.090	4.521	4.777	4.808	7.041	7.041	7.041
300.0000	6.477	5.053	7.041	6.580	5.228	4.555	4.838	4.876	7.041	7.041	7.041
400.0000	6.602	5.130	7.041	6.686	5.350	4.595	4.883	4.925	7.041	7.041	7.041
500.0000	6.699	5.207	7.041	6.781	5.458	4.624	4.918	4.964	7.041	7.041	7.041
600.0000	6.778	5.274	7.041	6.863	5.561	4.647	4.947	4.998	7.041	7.041	7.041
700.0000	6.845	5.338	7.041	6.934	5.664	4.667	4.974	5.029	7.041	7.041	7.041
760.0000	6.881	5.375	7.041	6.974	5.732	4.677	4.989	5.045	7.041	7.041	7.041
800.0000	6.903	5.400	7.041	6.999	5.774	4.685	4.998	5.057	7.041	7.041	7.041
900.0000	6.954	5.455	7.041	7.041	5.900	4.698	5.021	5.079	7.041	7.041	7.041
1000.0000	7.000	5.512	7.041	7.041	6.045	4.706	5.045	5.104	7.041	7.041	7.041

Values listed under each gas type are in volts.

The log-linear output signal and pressure are related by the following formulas:

$$P = 10^{(V - 4)} \quad V = \log_{10}(P) + 4 \quad \text{where } P \text{ is the pressure in Torr, and } V \text{ is the output signal in volts.}$$

An analog output of 10 volts indicates a faulty convection gauge or unplugged gauge cable.

The chart on the following page shows the graphical results of the table and formulas given above for nitrogen. True pressure (N₂) is plotted on the X-axis with a log scale. The output signal is plotted on the Y-axis on a linear scale.

Note - when using the units of pascals and LOG 0-7 is selected, the same equation of $P = 10^{(V - 4)}$ listed above applies. This results in a log-linear analog output range of 0 to 9.12 Vdc for 1.30E-02 pascals to 133 kpa.

LOG 0-7; Log-Linear Analog Output Voltage vs Pressure (Torr)

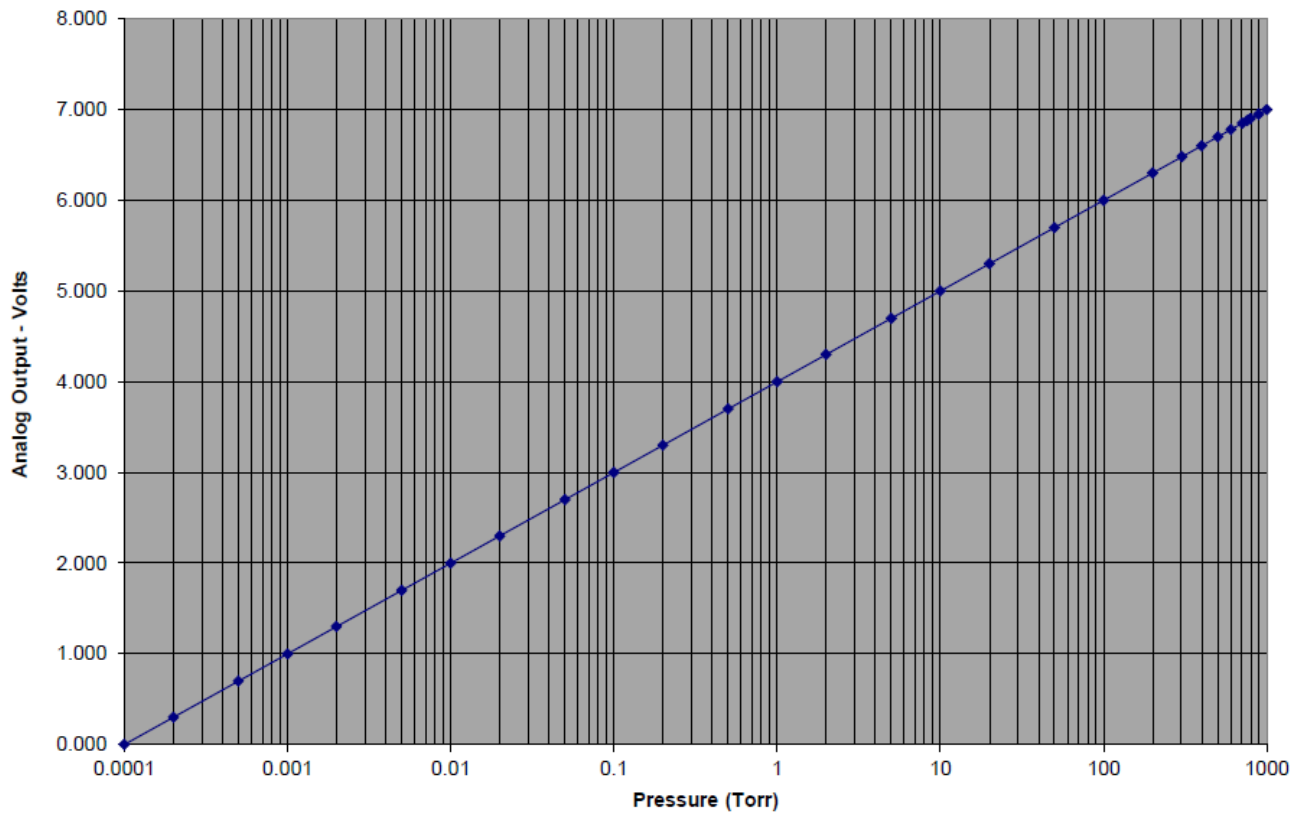

Chart of the calculated pressures using the formulas and data for the log-linear output signal for nitrogen from the previous page.

7.4 Log 0-7; Log-Linear Analog Output Equation & Table - mbar

Log-Linear 0 to 7 V analog output for selected gases - Engineering units in mbar

True Pressure (mBar)	N2	Ar	He	O2	CO2	KR	Freon12	Freon22	D2	Ne	CH4
0.0001	0.000	0.000	0.000	0.000	0.000	0.000	0.000	0.000	0.000	0.000	0.000
0.0002	0.301	0.301	0.301	0.301	0.301	0.301	0.301	0.301	0.301	0.301	0.301
0.0005	0.699	0.699	0.699	0.699	0.699	0.523	0.699	0.699	0.699	0.699	0.699
0.0010	1.000	0.903	0.938	1.000	1.028	0.668	1.125	1.125	1.080	0.903	1.167
0.0020	1.301	1.146	1.204	1.301	1.355	0.970	1.487	1.487	1.392	1.166	1.523
0.0050	1.699	1.524	1.602	1.699	1.672	1.370	1.883	1.855	1.778	1.551	1.893
0.0100	2.000	1.820	1.908	1.991	2.012	1.675	2.172	2.136	2.082	1.849	2.186
0.0200	2.301	2.188	2.208	2.294	2.345	1.979	2.473	2.434	2.385	2.150	2.484
0.0500	2.699	2.512	2.607	2.693	2.741	2.372	2.863	2.837	2.779	2.543	2.886
0.1000	3.000	2.809	2.928	2.989	3.033	2.671	3.157	3.136	3.082	2.844	3.197
0.2000	3.301	3.103	3.217	3.288	3.325	2.963	3.445	3.424	3.393	3.148	3.500
0.5000	3.699	3.495	3.634	3.686	3.696	3.341	3.798	3.783	3.828	3.553	3.893
1.0000	4.000	3.784	3.962	3.987	3.982	3.614	4.044	4.037	4.174	3.867	4.201
2.0000	4.301	4.064	4.324	4.288	4.249	3.865	4.250	4.255	4.579	4.192	4.517
5.0000	4.699	4.404	5.070	4.695	4.550	4.141	4.447	4.471	6.288	4.696	4.877
10.0000	5.000	4.633	7.125	5.008	4.743	4.309	4.556	4.602	7.125	5.252	5.374
20.0000	5.301	4.815	7.125	5.337	4.886	4.433	4.621	4.675	7.125	6.608	6.409
50.0000	5.699	4.969	7.125	5.862	5.002	4.514	4.680	4.722	7.125	7.125	6.930
100.0000	6.000	5.045	7.125	6.282	5.065	4.548	4.751	4.780	7.125	7.125	7.125
200.0000	6.301	5.093	7.125	6.526	5.157	4.606	4.851	4.877	7.125	7.125	7.125
300.0000	6.477	5.131	7.125	6.625	5.253	4.654	4.918	4.950	7.125	7.125	7.125
400.0000	6.602	5.178	7.125	6.705	5.353	4.679	4.962	5.000	7.125	7.125	7.125
500.0000	6.699	5.237	7.125	6.786	5.448	4.710	4.996	5.038	7.125	7.125	7.125
600.0000	6.778	5.295	7.125	6.861	5.532	4.734	5.025	5.070	7.125	7.125	7.125
700.0000	6.845	5.349	7.125	6.928	5.611	4.754	5.050	5.097	7.125	7.125	7.125
760.0000	6.881	5.380	7.125	6.965	5.658	4.765	5.063	5.112	7.125	7.125	7.125
800.0000	6.903	5.399	7.125	6.988	5.687	4.772	5.072	5.122	7.125	7.125	7.125
900.0000	6.954	5.488	7.125	7.042	5.766	4.787	5.092	5.146	7.125	7.125	7.125
1000.0000	7.000	5.494	7.125	7.092	5.847	4.799	5.111	5.167	7.125	7.125	7.125
1100.0000	7.041	5.539	7.125	7.125	5.936	4.812	5.128	5.187	7.125	7.125	7.125
1200.0000	7.079	5.580	7.125	7.125	6.028	4.822	5.146	5.204	7.125	7.125	7.125
1300.0000	7.114	5.624	7.125	7.125	6.140	4.828	5.164	5.222	7.125	7.125	7.125
1333.0000	7.125	5.636	7.125	7.125	6.169	4.830	5.169	5.228	7.125	7.125	7.125

Values listed under each gas type are in volts.

The log-linear output signal and pressure are related by the following formulas:

$$P = 10^{(V - 4)} \quad V = \log_{10}(P) + 4$$

where P is the pressure in mbar, and V is the output signal in volts.

An analog output of 10 volts indicates a faulty convection gauge or unplugged gauge cable.

The chart on the following page shows the graphical results of the table and formulas given above for nitrogen. True pressure (N₂) is plotted on the X-axis with a log scale. The output is plotted on the Y-axis on a linear scale.

Note - when using the units of pascals and LOG 0-7 is selected, the same equation of $P = 10^{(V - 4)}$ listed above applies. This results in a log-linear analog output range of 0 to 9.12 Vdc for 1.30E-02 pascals to 133 kpa.

LOG 0-7; Log-Linear Analog Output Voltage vs Pressure (mbar)

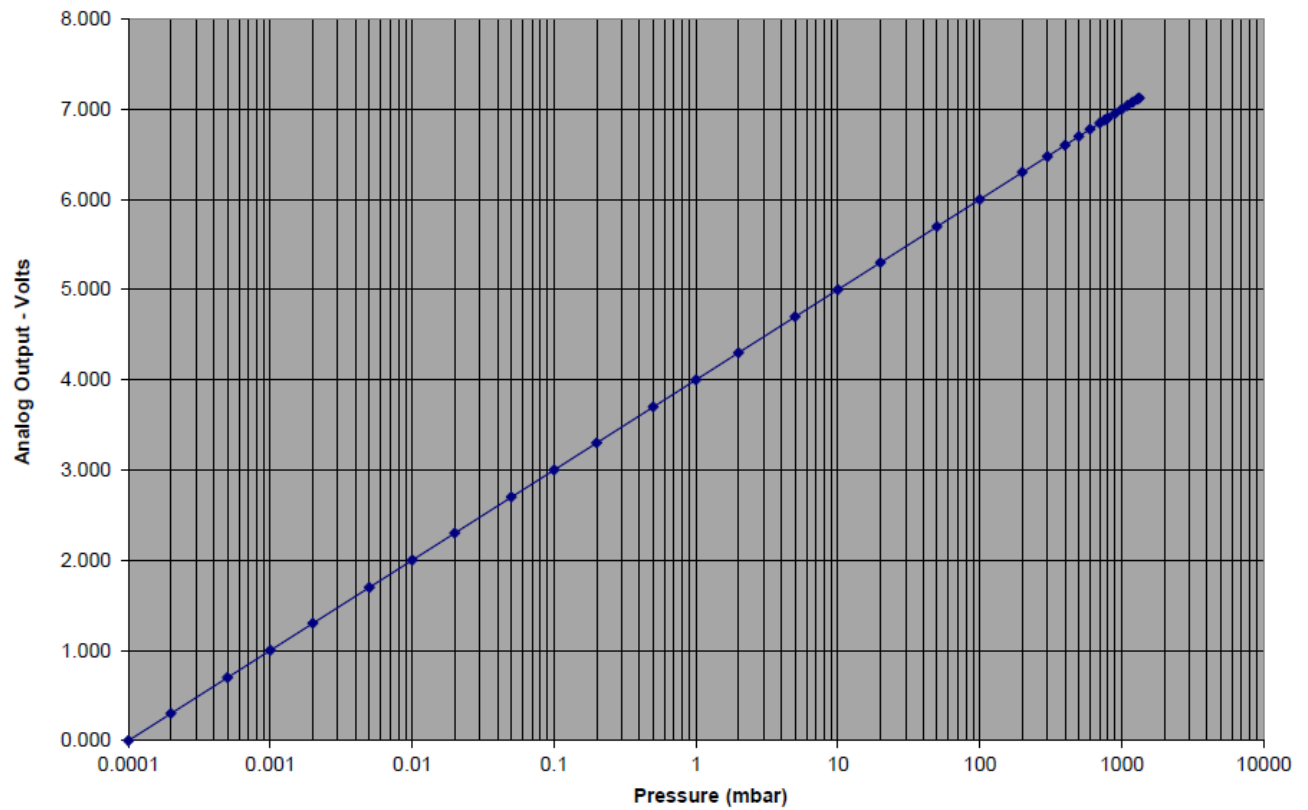

Chart of the calculated pressures using the formulas and data for the log-linear output signal for nitrogen from the previous page.

7.5 NONLIN 6V; Non-Linear Analog Output Equations

You may calculate the pressure represented by the NONLIN 6V, **0.375 to 5.659 V** non-linear analog output voltage for the “S-curve” using a multi-segment, nth order polynomial function calculation. The coefficients for the nth order polynomial equation defined for various pressure measurement ranges are given in the following table:

For Non-Linear Analog Output voltage range of **0.375 to 2.842 volts**, use this table.

Coefficients for $y(x) = a + bx + cx^2 + dx^3 + ex^4 + fx^5$	
a	-0.02585
b	0.03767
c	0.04563
d	0.1151
e	-0.04158
f	0.008738

For Non-Linear Analog Output voltage range of **2.842 to 4.945 volts**, use this table.

Coefficients for $y(x) = \frac{a+cx+ex^2}{1+bx+dx^2+fx^2}$	
a	0.1031
b	-0.3986
c	-0.02322
d	0.07438
e	0.07229
f	-0.006866

For Non-Linear Analog Output voltage range of **4.94 to 5.659 volts**, use this table.

Coefficients for $y(x) = \frac{a+cx}{1+bx+dx^2}$	
a	100.624
b	-0.37679
c	-20.5623
d	0.0348656

Where $y(x)$ = pressure in Torr, x = measured analog output in volts

Example: Measured analog output voltage is 0.3840 V.

From first table shown above use equation:

$$y(x) = a + bx + cx^2 + dx^3 + ex^4 + fx^5$$

X = 0.3840 volts

A = -0.02585, b=0.03767, c=0.04563, d=0.1151, e=-0.04158, f=0.008738

$y(x)$ = Pressure = 1.0E-03 Torr

The following tables in [section 7.6](#) and [section 7.7](#) are based on the equations listed above.

7.6 NONLIN 6V; Non-Linear Analog Output Table - Torr

Non-Linear 0.375 to 5.659 V analog output for selected gases - Engineering units in Torr/mTorr

True Total Pressure	N ₂	Ar	He	O ₂	CO ₂	Kr	Freon12	Freon22	D ₂	Ne	CH ₄
0 mTorr	0.3751	0.3750	0.3750	0.3750	0.3750	0.3750	0.3750	0.3750	0.3750	0.3750	0.3750
0.1 mTorr	0.3759	0.3757	0.3755	0.3760	0.3760	0.3755	0.3760	0.3760	0.3760	0.3757	0.3766
0.2 mTorr	0.3768	0.3760	0.3765	0.3770	0.3770	0.3768	0.3780	0.3780	0.3770	0.3763	0.3780
0.5 mTorr	0.3795	0.3780	0.3790	0.3800	0.3810	0.3772	0.3820	0.3810	0.3810	0.3782	0.3825
1 mTorr	0.3840	0.3810	0.3820	0.3840	0.3850	0.3790	0.3880	0.3880	0.3860	0.3810	0.3896
2 mTorr	0.3927	0.3870	0.3890	0.3920	0.3950	0.3840	0.4010	0.4000	0.3960	0.3880	0.4030
5 mTorr	0.4174	0.4030	0.4090	0.4170	0.4120	0.3950	0.4370	0.4320	0.4250	0.4050	0.4380
10 mTorr	0.4555	0.4290	0.4410	0.4530	0.4620	0.4150	0.4880	0.4800	0.4700	0.4330	0.4920
20 mTorr	0.5226	0.4770	0.4970	0.5210	0.5360	0.4510	0.5810	0.5660	0.5490	0.4840	0.5840
50 mTorr	0.6819	0.5950	0.6370	0.6790	0.7050	0.5440	0.7780	0.7640	0.7270	0.6080	0.7960
100 mTorr	0.8780	0.7450	0.8140	0.8680	0.9000	0.6680	1.0090	0.9900	0.9440	0.7680	1.0530
200 mTorr	1.1552	0.9620	1.0680	1.1410	1.1790	0.8470	1.3150	1.2910	1.2650	1.0020	1.3920
500 mTorr	1.6833	1.3860	1.5890	1.6640	1.6680	1.1940	1.8260	1.8050	1.9140	1.4690	2.0140
1 Torr	2.2168	1.8180	2.1640	2.1950	2.1720	1.5360	2.2570	2.2470	2.6030	1.9760	2.6320
2 Torr	2.8418	2.3330	2.9390	2.8140	2.6950	1.9210	2.6470	2.6660	3.5080	2.6310	3.3130
5 Torr	3.6753	3.0280	4.3870	3.6720	3.3160	2.4290	3.0290	3.0900	5.0590	3.7150	
10 Torr	4.2056	3.4800	5.7000	4.2250	3.6700	2.7340	3.2040	3.3300	5.7000	4.6050	4.6990
20 Torr	4.5766	3.8010	5.7000	4.6200	3.9030	2.9660	3.3080	3.4140	5.7000	5.4060	5.1720
50 Torr	4.8464	4.0370	5.7000	4.9160	4.0710	3.0750	3.4300	3.5090	5.7000	6.1590	5.5830
100 Torr	4.9449	4.1220	5.7000	5.0260	4.1540	3.1340	3.6180	3.6600	5.7000	6.4830	5.7200
200 Torr	5.0190	4.1920	5.7000	5.1060	4.3360	3.2690	3.8270	3.8830	5.7000	6.6610	5.8600
300 Torr	5.1111	4.2830	5.7000	5.2000	4.5020	3.3840	3.9380	4.0050	5.7000	6.7260	
400 Torr	5.2236	4.3860	5.7000	5.3150	4.6210	3.4660	4.0160	4.0880	5.7000	6.7670	6.1030
500 Torr	5.3294	4.4770	5.7000	5.4220	4.7080	3.5260	4.0760	4.1510	5.7000	6.8030	
600 Torr	5.4194	4.5500	5.7000	5.5150	4.7750	3.5730	4.1240	4.2030	5.7000	6.8430	6.3420
700 Torr	5.4949	4.6110	5.7000	5.5920	4.8300	3.6130	4.1660	4.2470	5.7000	6.8900	
760 Torr	5.5340	4.6430	5.7000	5.6330	4.8600	3.6320	4.1900	4.2710	5.7000	6.9200	
800 Torr	5.5581	4.6630	5.7000	5.6580	4.8770	3.6450	4.2030	4.2860	5.7000	6.9420	6.5190
900 Torr	5.6141	4.7060	5.7000	5.7130	4.9190	3.6740	4.2370	4.3210	5.7000	7.0000	
1000 Torr	5.6593	4.7450	5.7000	5.7620	4.9550	3.6900	4.2700	4.3540	5.7000	7.0560	6.6420

Values listed under each gas type are in volts.

Note: By design, these values are identical to the outputs from Brooks Automation, Inc. / Granville-Phillips® Convector® gauges, Mini-Convector® modules and controllers so that equivalent units can be interchanged without affecting your process system or software.

An analog output of 10 volts indicates a faulty convection gauge or unplugged gauge cable.

7.7 NONLIN 6V; Non-Linear Analog Output Table - mbar

Non-Linear 0.375 to 5.659 V analog output for selected gases - Engineering units in mbar

True Pressure	N ₂	Ar	He	O ₂	CO ₂	KR	Freon12	Freon22	D ₂	Ne	CH ₄
0 mbar	0.3751	0.375	0.375	0.375	0.375	0.375	0.375	0.375	0.375	0.375	0.375
.0001 mbar	0.3759	0.3757	0.376	0.376	0.376	0.376	0.376	0.376	0.376	0.3757	0.3766
.0003 mbar	0.3768	0.376	0.377	0.377	0.377	0.377	0.378	0.378	0.377	0.3763	0.378
.0006 mbar	0.3795	0.378	0.379	0.38	0.381	0.377	0.382	0.381	0.381	0.3782	0.3825
.0013 mbar	0.384	0.381	0.382	0.384	0.385	0.379	0.388	0.388	0.386	0.381	0.3896
.0027 mbar	0.3927	0.387	0.389	0.392	0.395	0.384	0.401	0.4	0.396	0.388	0.403
.0067 mbar	0.4174	0.403	0.409	0.417	0.412	0.395	0.437	0.432	0.425	0.405	0.438
.0133 mbar	0.4555	0.429	0.441	0.453	0.462	0.415	0.488	0.48	0.47	0.433	0.492
.0266 mbar	0.5226	0.477	0.497	0.521	0.536	0.451	0.581	0.566	0.549	0.484	0.584
.0660 mbar	0.6819	0.595	0.637	0.679	0.705	0.544	0.778	0.764	0.727	0.608	0.796
0.13 mbar	0.878	0.745	0.814	0.868	0.9	0.668	1.009	0.99	0.944	0.768	1.053
0.26 mbar	1.1552	0.962	1.068	1.141	1.179	0.847	1.315	1.291	1.265	1.002	1.392
0.66 mbar	1.6833	1.386	1.589	1.664	1.668	1.194	1.826	1.805	1.914	1.469	2.014
1.33 mbar	2.2168	1.818	2.164	2.195	2.172	1.536	2.257	2.247	2.603	1.976	2.632
2.66 mbar	2.8418	2.333	2.939	2.814	2.695	1.921	2.647	2.666	3.508	2.631	3.313
6.66 mbar	3.6753	3.028	4.387	3.672	3.316	2.429	3.029	3.09	5.059	3.715	
13.3 mbar	4.2056	3.48	5.700	4.225	3.67	2.734	3.204	3.33	5.700	4.605	4.699
26.6 mbar	4.5766	3.801	5.700	4.62	3.903	2.966	3.308	3.414	5.700	5.406	5.172
66.6 mbar	4.8464	4.037	5.700	4.916	4.071	3.075	3.43	3.509	5.700	6.159	5.583
133 mbar	4.9449	4.122	5.700	5.026	4.154	3.134	3.618	3.66	5.700	6.483	5.72
266 mbar	5.019	4.192	5.700	5.106	4.336	3.269	3.827	3.883	5.700	6.661	5.86
400 mbar	5.1111	4.283	5.700	5.2	4.502	3.384	3.938	4.005	5.700	6.726	
533 mbar	5.2236	4.386	5.700	5.315	4.621	3.466	4.016	4.088	5.700	6.767	6.103
666 mbar	5.3294	4.477	5.700	5.422	4.708	3.526	4.076	4.151	5.700	6.803	
800 mbar	5.4194	4.55	5.700	5.515	4.775	3.573	4.124	4.203	5.700	6.843	6.342
933 mbar	5.4949	4.611	5.700	5.592	4.83	3.613	4.166	4.247	5.700	6.89	
1010 mbar	5.534	4.643	5.700	5.633	4.86	3.632	4.19	4.271	5.700	6.92	
1060 mbar	5.5581	4.663	5.700	5.658	4.877	3.645	4.203	4.286	5.700	6.942	6.519
1190 mbar	5.6141	4.706	5.700	5.713	4.919	3.674	4.237	4.321	5.700	7	
1330 mbar	5.6593	4.745	5.700	5.762	4.955	3.69	4.270	4.354	5.700	7.056	6.642

Values listed under each gas type are in volts.

Note: By design, these values are identical to the outputs from Brooks Automation, Inc. / Granville-Phillips® Convector® gauges, Mini-Convector® modules and controllers so that equivalent units can be interchanged without affecting your process system or software.

An analog output of 10 volts indicates a faulty convection gauge or unplugged gauge cable.

7.8 NONLIN 9V; Non-Linear Analog Output Equations & Table

You may calculate the pressure represented by the NONLIN 9V, 0 to 9 V non-linear analog output voltage for the “S-curve” using a multi-segment, nth order polynomial function calculation. Use the coefficients listed in the table below to calculate pressure using the following equation:

$$P = K_0 + K_1(454.67*V_1) + K_2(454.67*V_1)^2 + K_3(454.67*V_1)^3$$

Where P=Pressure in Torr, V₁= Analog output voltage

Coefficients for voltage segment range of 0 to 1.8457 volts	
K ₀	K ₀ = +0.000000E+00
K ₁	K ₁ = +1.428571E-04
K ₂	K ₂ = +2.551020E-07
K ₃	K ₃ = +9.110787E-11

Coefficients for voltage segment range of 1.8457 to 3.1641 volts	
K ₀	K ₀ = -2.681040E-01
K ₁	K ₁ = +9.758000E-04
K ₂	K ₂ = -5.950000E-07
K ₃	K ₃ = +3.750000E-10

Coefficients for voltage segment range of 3.1641 to 4.3945 volts	
K ₀	K ₀ = +1.100000E+00
K ₁	K ₁ = -1.675000E-03
K ₂	K ₂ = +1.125000E-06
K ₃	K ₃ = +7.414069E-21

Coefficients for voltage segment range of 4.3945 to 6.54785 volts	
K ₀	K ₀ = -3.777930E+01
K ₁	K ₁ = +5.495931E-02
K ₂	K ₂ = -2.652588E-05
K ₃	K ₃ = +4.526774E-09

Coefficients for voltage segment range of 6.54785 to 7.3828 volts	
K ₀	K ₀ = -7.184400E+03
K ₁	K ₁ = +7.117083E+00
K ₂	K ₂ = -2.354167E-03
K ₃	K ₃ = +2.604167E-07

Coefficients for voltage segment range of 7.3828 to 7.6465 volts	
K ₀	K ₀ = -5.439800E+04
K ₁	K ₁ = +4.990375E+01
K ₂	K ₂ = -1.528125E-02
K ₃	K ₃ = +1.562500E-06

Coefficients for voltage segment range of 7.6465 to 7.9102 volts	
K ₀	K ₀ = +1.811462E+06
K ₁	K ₁ = -1.511014E+03
K ₂	K ₂ = +4.196562E-01
K ₃	K ₃ = -3.880208E-05

Coefficients for voltage segment range of 7.9102 to 9 volts	
K ₀	K ₀ = -2.417225E+05
K ₁	K ₁ = +1.919958E+02
K ₂	K ₂ = -5.106048E-02
K ₃	K ₃ = +4.554342E-06

Example: Measured analog output voltage is: V₁ = 5.6243 V.

Since analog output in this example is 5.6243 V, use the Coefficients from the fourth table shown in the previous page:

$$K_0 = -3.777930E+01, \quad K_1 = +5.495931E-02, \quad K_2 = -2.652588E-05, \quad K_3 = +4.526774E-09$$

$$\text{Use equation from the previous page; } P = K_0 + K_1(454.67 * V_1) + K_2(454.67 * V_1)^2 + K_3(454.67 * V_1)^3$$

P = Pressure = 5.00 Torr

The following pressure vs. voltage table is derived from equations and coefficients listed above.

NONLIN 9V, Non-Linear Output Voltage vs. Pressure in Torr units for N₂/Air

Pressure (Torr)	Voltage (Vdc)	Pressure (Torr)	Voltage (Vdc)	Pressure (Torr)	Voltage (Vdc)
0.0000	0.0000	2.0E-01	1.3310	4.0E+02	8.2587
1.0E-04	0.0016	5.0E-01	2.2289	5.0E+02	8.4375
2.0E-04	0.0031	1.0E+00	3.1352	6.0E+02	8.5915
5.0E-04	0.0077	2.0E+00	4.1968	7.0E+02	8.7196
1.0E-03	0.0153	5.0E+00	5.6243	7.6E+02	8.7862
2.0E-03	0.0302	1.0E+01	6.5245	8.0E+02	8.8271
5.0E-03	0.0727	2.0E+01	7.1531	9.0E+02	8.9193
1.0E-02	0.1385	5.0E+01	7.6145	1.0E+03	9.0000
2.0E-02	0.2536	1.0E+02	7.7804		
5.0E-02	0.5260	2.0E+02	7.9102		
1.0E-01	0.8583	3.0E+02	8.0743		

An analog output of 10 volts indicates a faulty convection gauge or unplugged gauge cable.

7.9 LINEAR

The VGC301 analog output may be setup to provide a 0-10 Vdc output signal that has a direct linear relationship to the displayed pressure. When preparing to setup and process the linear analog output signal, first define the following parameters that you will program into the VGC301:

- Minimum measured pressure (for the defined analog output range)
- Minimum output voltage desired (proportional to the minimum pressure)
- Maximum measured pressure (for the analog output signal range)
- Maximum output voltage desired (proportional to maximum pressure)

Constructing a table of these parameters may be useful in documenting the relationship of displayed pressure to the analog output voltage. For example, the following table is representative of a typical setup where;

Min P = 1.00E-03 Torr Min Voltage = 0.01 Volts

Max P = 1.00 Torr Max Voltage = 10 V

<u>Linear Analog Output Voltage - volts</u>	<u>Measured (Displayed) Pressure - torr</u>
0.01	1.00E -03
0.10	1.00E -02
1.00	1.00E -01
10.00	1.00E +00

It is recommended that the *Linear* output signal be setup such that the range covers, at most, 3 decades of pressure change. For example, if the minimum pressure selected is 1 mtorr (1.0E -03 torr) with a corresponding minimum voltage output of 0.01 volts, then the maximum pressure selected to correspond to a maximum voltage of 10.0 volts should not exceed 1.0 torr.

Doing this is considered best practice when using this type of analog output signal with the VGC301.

If your application requires the analog output voltage to cover a pressure range exceeding three decades, then consider using the log-linear or non-linear analog output.

Note - When using the LINEAR (0-10 Vdc) analog output, an output of 11 volts indicates a faulty convection gauge or unplugged gauge cable.

8 RS485 / RS232 serial communications

8.1 Device Specific Serial Communication Info

The standard VGC301 model provides RS232 / RS485 serial communications. The following information and the RS485 / RS232 command protocol summary listed on the next page should be used to set serial communications with the device.

1. Default settings are 19,200 baud rate, 8 data bits, No Parity, 1 stop bit [Factory default; 19,200, 8, N, 1].
2. The baud rate can be set to different values through the serial interface command set or the front panel push buttons.
3. The parity can be changed only through the serial interface command set and the number of data bits will change according to the parity selected.
4. The stop bit is always 1.
5. All Responses are 13 characters long.
6. xx is the address of the device (00 thru FF).
7. <CR> is a carriage return.
8. _ is a space.
9. The 'z' in the set or read trip point commands is a + or -. The plus is the 'turns on below' point and the minus is the 'turns off above' point.
10. All commands sent to the controller start with a '#' character, and all responses from the controller start with a '*' character.
11. This protocol was designed to be 100% compatible with the Granville-Phillips® Mini-Convectron®.
12. A valid address must be used even in RS232 commands [Factory default = 1].

8.2 RS485 / RS232 Command Protocol Summary

COMMAND	BRIEF DESCRIPTION	COMMAND SYNTAX	RESPONSE
READ	Read the current pressure in Torr	#xxRD<CR> (eg: #01RD<CR>)	*xx_y.yyEzzy<CR> (eg: *01_7.60E+02<CR>)
SET ADDR OFFSET	Set the communications (RS485) address offset (upper nibble) ⁽¹⁾	#xxSAxx<CR> (eg: #01SA20<CR>)	*xx_PROGM_OK<CR>
SET SPAN	Set the span or atmosphere calibration point	#xxTSy.yyEzzy<CR> (eg: #01TS7.60E+02)	*xx_PROGM_OK<CR>
SET ZERO	Set the zero or vacuum calibration point	#xxTZy.yyEzzy<CR> (eg: #01TZ0.00E-04<CR>)	*xx_PROGM_OK<CR>
SET TRIP POINT #1	Set the 'turns on below' pressure point for relay #1 and set the 'turns off above' pressure point for relay #1.	#xxSLzy.yyEzzy<CR> (eg: #01SL+4.00E+02<CR>) (eg: #01SL-5.00E+02<CR>)	*xx_`PROGM_OK<CR>
SET TRIP POINT #2	Set the 'turns on below' pressure point for relay #2 and set the 'turns off above' pressure point for relay #2.	#xxSHzy.yyEzzy<CR> (eg: #01SH+4.00E+02<CR>) (eg: #01SH-5.00E+02<CR>)	*xx_PROGM_OK<CR>
READ TRIP POINT #1	Read the 'turns on below' pressure point for relay #1 and read the 'turns off above' pressure point for relay #1.	#xxRLz<CR> (eg: #01RL+<CR>) (eg: #01RL-<CR>)	*xx_y.yyEzzy<CR> (eg: *01_7.60E+02<CR>)
READ TRIP POINT #2	Read the 'turns on below' pressure point for relay #2 and read the 'turns off above' pressure point for relay #2.	#xxRHZ<CR> (eg: #01RH+<CR>) (eg: #01RH-<CR>)	*xx_y.yyEzzy<CR> (eg: *01_7.60E+02<CR>)
READ SW VERSION	Read the revision number of the firmware.	#xxVER<CR> (eg: #01VER<CR>)	*xx_mmmnv-vv (eg: *0105041-00)
SET FACTORY DEFAULTS	Force unit to return ALL settings back to the way the factory programmed them before shipment. ⁽¹⁾	#xxFAC<CR> (eg: #01FAC<CR>)	*xx_PROGM_OK<CR>
SET BAUD RATE	Set the communications baud rate for RS485 and RS232. ⁽¹⁾	#xxSByyyyy<CR> (eg: #01SB19200<CR>)	*xx_PROGM_OK<CR>
SET NO PARITY	Set the communications to NO parity, 8 bits for the RS485 and RS232. ⁽¹⁾	#xxSPN<CR> (eg: #01SPN<CR>)	*xx_PROGM_OK<CR>
SET ODD PARITY	Set the communications to ODD parity, 7 bits for the RS485 and RS232. ⁽¹⁾	#xxSPO<CR> (eg: #01SPO<CR>)	*xx_PROGM_OK<CR>
SET EVEN PARITY	Set the communications to EVEN parity, 7 bits for the RS485/RS232. ⁽¹⁾	#xxSPE<CR> (eg: #01SPE<CR>)	*xx_PROGM_OK<CR>
RESET	Reset the device. (required to complete some of the commands.)	#xxRST<CR> (eg: #01RST<CR>)	No response

(1) Commands marked with a ⁽¹⁾ under the "BRIEF DESCRIPTION" column will not take effect until after RESET command is sent or power is cycled.

9 Service

9.1 Calibration

Every InstruTech CVG101 sensor is calibrated prior to shipment using nitrogen (N₂). However, you can calibrate the instrument by adjusting zero and span (atmosphere) using the procedure described previously in [section 4.2 titled “Programming”](#). Zero and span (atmosphere) calibration affect the displayed value and the output signal. Zero calibration optimizes performance of the gauge when operating at a low pressure range of 1 x 10⁻⁴ Torr to 1 x 10⁻³ Torr. If your minimum operating pressure is higher than 1 x 10⁻³ Torr, it is not normally necessary to perform calibration at zero and thus span calibration should be adequate. If you are able to evacuate your system to below 1 x 10⁻⁴ Torr, it is always a good practice to check and set zero if necessary. This will also improve performance in cases where gauge contamination is causing higher readings than 1 x 10⁻⁴ Torr even though the system has been evacuated to below 1 x 10⁻⁴ Torr. Care should be exercised when using gases other than nitrogen (N₂) / air.

9.2 Maintenance

In general, maintenance is not required for your InstruTech sensor and controller. Periodic performance checks may be done by comparing the sensor to a known reference standard.

9.3 Troubleshooting

Indication	Possible Cause	Possible Solution
Display is off / blank	No power	Check power supply & power cable
Readings appear very different from expected pressure	The process gas is different from the gas used to calibrate the CVG101 gauge CVG101 gauge has not been calibrated or has been calibrated incorrectly	Correct readings for different gas thermal conductivity. See section 5 on using the gauge with different gases Check that zero and span are adjusted correctly
Readings are noisy or erratic	Loose cables or connections Contamination Vibration	Check and tighten connections Inspect the CVG101 for signs of contamination such as particles, deposits, discoloration on gauge inlet. Return to factory for possible cleaning Ensure gauge is not mounted where excessive vibration is present
Gauge cannot be calibrated - zero and span can't be adjusted	Contamination Sensor failure for other cause	Return the CVG101 to factory for possible cleaning Replace the CVG101
Setpoint does not actuate	Incorrect setup	Check setpoint setup
Display shows “Sensor Bad”	Sensor wire damaged	Replace the CVG101
Display shows “overpressure”	System pressure over 1000 Torr Faulty electronics	Reduce pressure Repair or replace the VGC301 electronics
Atmospheric pressure reads too high and can't be set to correct value	Contamination Sensor wire damaged	Return the CVG101 to factory for possible cleaning Replace the CVG101
Atmospheric pressure reads too low and can't be set to correct value	Sensor wire damaged Contamination	Replace the CVG101 Return the CVG101 to factory for possible cleaning

10 Factory Service and Support

If you need help setting up, operating, troubleshooting, or obtaining a return materials authorization number (RMA number) to return the controller for diagnosis, please contact us during normal business hours (8:00am to 5:00pm Mountain time) Monday through Friday, at 303-651-0551. Or e-mail us at support@instrutechinc.com.

If you intend to also return the vacuum gauge sensor used with the controller, for the safety of our employees, you must download, complete and submit a material disclosure form from our website at www.instrutechinc.com. Please use this form to provide a history of the gauge detailing what gases have been used. We cannot accept gauges that have been exposed to hazardous materials.

11 Warranty

SELLER warrants that its products are free of defects in workmanship and material and fit for the uses set forth in SELLER's catalog or product specifications, under the normal use and service for which they are intended.

The entire warranty obligation of SELLER is for the repair or replacement, at SELLER's option, of products or parts (examination of which shall disclose to SELLER's satisfaction that it is defective) returned, to SELLER's plant, properly identified within five years (unless otherwise noted) after the date of shipment from InstruTech Plant. BUYER must obtain the approval of SELLER and a return authorization number prior to shipment.

Alteration or removal of serial numbers or other identification marks renders this warranty void. The warranty does not apply to products or components which have been abused, altered, operated outside of the environmental specifications of the product, improperly handled or installed, or units which have not been operated in accordance with SELLER's instructions. Furthermore the warranty does not apply to products that have been contaminated, or when the product or part is damaged during the warranty period due to causes other than ordinary wear and tear to the product including, but not limited to, accidents, transportation, neglect, misuse, use of the product for any purpose other than that for which it was designed.

THIS WARRANTY IS EXCLUSIVE AND IN LIEU OF ALL OTHER WARRANTIES, EXPRESS OR IMPLIED, INCLUDING ANY IMPLIED WARRANTY OF MERCHANTABILITY OR FITNESS FOR A PARTICULAR PURPOSE. THIS WARRANTY EXTENDS ONLY IN FAVOR OF THE ORIGINAL BUYER. THE BUYER'S SOLE REMEDY SHALL BE THE REPAIR OR REPLACEMENT, AS IS EXPRESSLY PROVIDED HEREIN, OF ANY WARRANTED DEFECTIVE PRODUCT OR PART, AND UNDER NO CIRCUMSTANCE SHALL SELLER BE LIABLE TO BUYER OR ANYONE ELSE FOR ANY CONSEQUENTIAL DAMAGES TO PERSONS OR PROPERTY, FOR INCIDENTAL DAMAGES OR LOSS OF TIME, FOR ANTICIPATED OR LOST PROFITS, OR ANY OTHER LOSS INCURRED BY THE BUYER RELATED TO THE PRODUCT COVERED BY THIS WARRANTY. THIS EXCLUSIVE REMEDY SHALL NOT BE DEEMED TO HAVE FAILED OF ITS ESSENTIAL PURPOSE SO LONG AS SELLER IS WILLING AND ABLE TO REPAIR OR REPLACE DEFECTIVE PARTS IN THE PRESCRIBED MANNER. THIS LIMITED WARRANTY MAY NOT BE MODIFIED BY SELLER UNLESS SUCH MODIFICATION OR WAIVER IS IN WRITING, EXECUTED BY AN AUTHORIZED OFFICER OF SELLER.



InstruTech[®], Inc.

1475 S. Fordham St.
Longmont, CO 80503
USA

Phone +1-303-651-0551
Fax +1-303-678-1754
E-mail info@instrutechinc.com
www.instrutechinc.com